

TeSys[®] T LTM CU

Control Operator Unit

User Manual

06/2014



1639581EN-04

www.schneider-electric.com

Schneider
Electric

The information provided in this documentation contains general descriptions and/or technical characteristics of the performance of the products contained herein. This documentation is not intended as a substitute for and is not to be used for determining suitability or reliability of these products for specific user applications. It is the duty of any such user or integrator to perform the appropriate and complete risk analysis, evaluation and testing of the products with respect to the relevant specific application or use thereof. Neither Schneider Electric nor any of its affiliates or subsidiaries shall be responsible or liable for misuse of the information contained herein. If you have any suggestions for improvements or amendments or have found errors in this publication, please notify us.

No part of this document may be reproduced in any form or by any means, electronic or mechanical, including photocopying, without express written permission of Schneider Electric.

All pertinent state, regional, and local safety regulations must be observed when installing and using this product. For reasons of safety and to help ensure compliance with documented system data, only the manufacturer should perform repairs to components.

When devices are used for applications with technical safety requirements, the relevant instructions must be followed.

Failure to use Schneider Electric software or approved software with our hardware products may result in injury, harm, or improper operating results.

Failure to observe this information can result in injury or equipment damage.

© 2014 Schneider Electric. All rights reserved.

Table of Contents



	Safety Information	5
	About the Book	7
Chapter 1	Introducing the LTM CU Control Operator Unit	9
	Presentation of the LTM CU Control Operator Unit	10
	Installing SoMove and the TeSys DTM Library	12
	Technical Specifications of the LTM CU	13
Chapter 2	Installing the LTM CU Control Operator Unit	15
	LTM CU Dimensions	16
	Inserting the Local Control Interface Label	17
	Flush Mounting the LTM CU	19
	Mounting a Portable LTM CU	21
	Connecting the LTM CU	23
Chapter 3	Language Management	25
	Presentation of LTMCU Langtool	26
	Using LTMCU Langtool	28
Chapter 4	Using the LTM CU Control Operator Unit	33
	LTM CU Physical Description	34
	Parameter Display	37
	Quick View Display	39
	Detected Faults and Warnings Display	41
	Using the Local Control Interface	42
	Navigating the Menu Structure	45
	Editing Values	46
	Password Access	49
	Selecting the Language Displayed by the LTM CU	50
	First Setup Menu	51
	Main Menu	52
	Menu - Metering Setting	53
	Menu - Protection Setting	54
	Menu - Control Setting	58
	Menu - Services	60
Index	67



Safety Information



Important Information

NOTICE

Read these instructions carefully, and look at the equipment to become familiar with the device before trying to install, operate, or maintain it. The following special messages may appear throughout this documentation or on the equipment to warn of potential hazards or to call attention to information that clarifies or simplifies a procedure.



The addition of this symbol to a “Danger” or “Warning” safety label indicates that an electrical hazard exists which will result in personal injury if the instructions are not followed.



This is the safety alert symbol. It is used to alert you to potential personal injury hazards. Obey all safety messages that follow this symbol to avoid possible injury or death.

DANGER

DANGER indicates a hazardous situation which, if not avoided, **will result in** death or serious injury.

WARNING

WARNING indicates a hazardous situation which, if not avoided, **could result in** death or serious injury.

CAUTION

CAUTION indicates a hazardous situation which, if not avoided, **could result in** minor or moderate injury.

NOTICE

NOTICE is used to address practices not related to physical injury.

PLEASE NOTE

Electrical equipment should be installed, operated, serviced, and maintained only by qualified personnel. No responsibility is assumed by Schneider Electric for any consequences arising out of the use of this material.

A qualified person is one who has skills and knowledge related to the construction and operation of electrical equipment and its installation, and has received safety training to recognize and avoid the hazards involved.

About the Book



At a Glance

Document Scope

This manual describes how to install, configure and use the TeSys® T LTM CU Control Operator Unit. The firmware version of the LTM R connected to the LTM CU must be LTM CU compliant: the LTM R firmware version must be 2.1 and above.

Validity Note

This manual is valid for all LTM CU Control Operator Units. The availability of some functions depends on the software version of the Control Operator Unit.

Related Documents

Title of Documentation	Reference Number
TeSys® T LTM R Modbus Motor Management Controller User Manual	1639501
TeSys® T LTM R Profibus Motor Management Controller User Manual	1639502
TeSys® T LTM R CANopen Motor Management Controller User Manual	1639503
TeSys® T LTM R DeviceNet Motor Management Controller User Manual	1639504
TeSys® T LTM R Ethernet TCP/IP Motor Management Controller User Manual	1639505
TeSys® T LTM CU•• Instruction Sheet	1639582

You can download these technical publications and other technical information from our website at www.schneider-electric.com.

Chapter 1

Introducing the LTM CU Control Operator Unit

Overview

This chapter introduces the LTM CU Control Operator Unit, and describes its function and technical specifications.

What Is in This Chapter?

This chapter contains the following topics:

Topic	Page
Presentation of the LTM CU Control Operator Unit	10
Installing SoMove and the TeSys DTM Library	12
Technical Specifications of the LTM CU	13

Presentation of the LTM CU Control Operator Unit

Aim of the Product

The LTM CU Control Operator Unit is a remote operator terminal that enables the configuration, monitoring and control of the LTM R controller, as part of the TeSys® T Motor Management System. The LTM CU has been specially developed to act as the Human Machine Interface (HMI) of the LTM R controller, and is internally powered by the LTM R.

The diagram below shows the LTM CU front face:

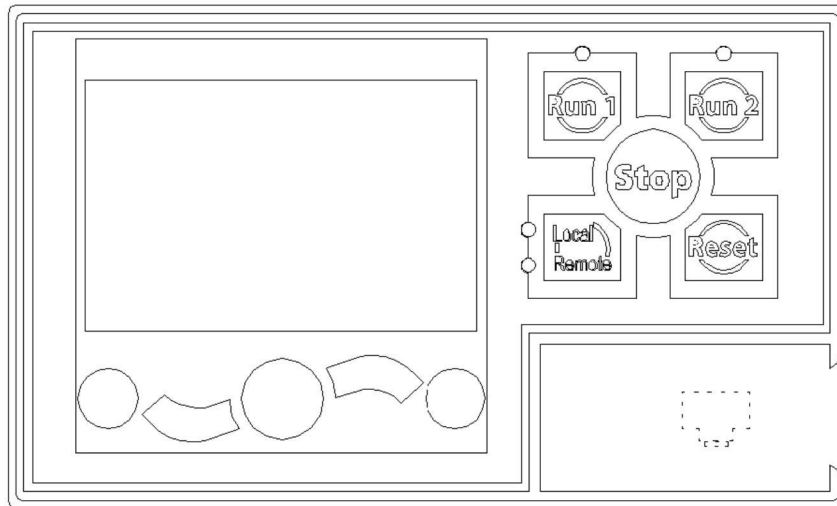

LTM CU Functions

The LTM CU can be used to:

- configure parameters for the LTM R controller,
- display information about the LTM R controller configuration and operation,
- monitor detected faults and warnings detected by the controller,
- control the motor locally using the local control interface.

LTM CU Languages

The LTM CU can display languages thanks to an embedded dictionary. The default (factory) language is English. You can also download and install 2 other languages via www.schneider-electric.com. For more information on downloading languages, see *Language Management*, page 25.

Configuring the LTM R Controller Using SoMove™ with the TeSys T DTM

The LTM R controller can be configured using the LTM CU or a PC running SoMove with the TeSys T DTM. (see page 12).

SoMove software is a Microsoft® Windows®-based application, using the open FDT/DTM technology.

SoMove contains many DTMs. The TeSys T DTM is a specific DTM that enables the configuration, monitoring, control, and customization of the control functions of the LTM R controller, as part of the TeSys® T motor management system.

LTM CU Assembly

There are 2 ways to use the LTM CU:

- as a fixed HMI device, flush mounted in a panel and continuously connected to one LTM R controller (see page 19), or
- as a portable HMI device, used from time to time to set and monitor several LTM R controllers. A separate kit (reference LTM9KCU) is required to mount the portable LTM CU.

More Information in LTM R User's Manuals

The User's Manual of the LTM R controller used is complementary to the present manual and needed for the system implementation. It contains the following information:

- description of the functions (metering and monitoring, protection and control),
- parameter values (including factory default),
- installation and commissioning.

Installing SoMove and the TeSys DTM Library

Overview

The installation of SoMove includes some DTMs such as the TeSys DTM library.

The TeSys DTM library includes:

- TeSys T DTM
- TeSys U DTM

These DTM are automatically installed during the SoMove installation process.

Downloading SoMove

SoMove can be downloaded from the Schneider Electric website (www.schneider-electric.com) by entering SoMove Lite in the **Search** field.

Installing SoMove

Step	Action
1	Unzip the downloaded file: the SoMove file is unzipped in a folder named <i>SoMove_Lite - V.X.X.X.X</i> (where X.X.X.X is the version number). Open this folder and double-click setup.exe .
2	In the Choose Setup Language dialog box, select the installation language.
3	Click OK .
4	In the Welcome to the Installation Wizard for SoMove Lite dialog box, click the Next button.
5	If an Install Shield Wizard dialog box appears and informs you that you must install Modbus driver, click the Install button. Result: Modbus driver is installed automatically.
6	In the Readme and Release Notes dialog box, click the Next button.
7	In the Readme dialog box, click the Next button.
8	In the License Agreement dialog box: <ul style="list-style-type: none"> ● Read carefully the license agreement. ● Select I accept the terms in the license agreement option. ● Click the Next button.
9	In the Customer Information dialog box: <ul style="list-style-type: none"> ● Enter the following information in the corresponding fields: <ul style="list-style-type: none"> ● First name ● Last name ● Company name ● Select an installation option: <ul style="list-style-type: none"> ● Either the Anyone who uses this computer option if SoMove Lite is used by all users of this computer, or ● Only for me if SoMove Lite is used only by you. ● Click the Next button.
10	In the Destination Folder dialog box: <ul style="list-style-type: none"> ● If necessary, modify the SoMove Lite destination folder by clicking the Change button. ● Click the Next button.
11	In the Shortcuts dialog box: <ul style="list-style-type: none"> ● If you want to create a shortcut on the desktop and/or in the quick launch bar, select the corresponding options. ● Click the Next button.
12	In the Ready to Install the Program dialog box, click the Install button. Result: The SoMove Lite components are installed automatically: <ul style="list-style-type: none"> ● Modbus communication DTM library which contains the communication protocol ● DTM libraries which contain different drive catalogs ● SoMove Lite itself
13	In the Installation Wizard Completed dialog box, click the Finish button. Result: SoMove Lite is installed on your computer.

Technical Specifications of the LTM CU

Environmental Characteristics

Certification (1)	UL, CSA, CE, EAC/GOST, RCM/CTIC'K		
Conformity to Standards	IEC/EN 61131-2, UL60947-4-1A, CSA C22.2 no. 60947-4-1		
European community directives	CE marking, satisfies the essential requirements of the low voltage (LV) machinery and electromagnetic compatibility (EMC) directives.		
Ambient air temperature around the device	Storage		-40...+80 °C (-40...176 °F)
	Operation	inside cabinet	-20...+60 °C (-4...140 °F)
		outside cabinet	-20...+55 °C (-4...131 °F)
Humidity range	15 to 95 % (without condensation)		
Cycled humidity	According to IEC/EN 60068-2-30 (variant 2)	55 °C (131 °F); 12 cycles	
Degree of protection	According to IEC 60947-1 (protection against direct contact)	IP54 (part outside cabinet)	
		IP20 (part inside cabinet)	
	According to NEMA	Type 12 (part outside cabinet)	
		Type 1 (part inside cabinet)	
Resistance to shocks	According to IEC 60068-2-27 (2)	Semi-sine mechanical shock impulse: 11 ms, 15 g on 3 axes	
Resistance to vibration	According to IEC 60068-2-6 (2)	5...300 Hz: 4 g	
Fire resistance	According to IEC 60947-1	650 °C (1,202 °F)	
	According to UL94	V2 V1 for plastic parts on front cover	
Degree of pollution	According to IEC/EN 61131	Degree 2	
Overtoltage category	According to IEC/EN 61131	II	
<p>(1) Some certifications are in progress.</p> <p>(2) NOTICE: This product has been designed for use in Zone A as defined in IEC 61131-2. Use of this product in Zone B may cause unwanted electromagnetic disturbance, which may require the implementation of adequate mitigation measures.</p>			

Electrical Noise Immunity

Immunity to electrostatic discharge	According to EN61000-4-2	Through air	8 kV level 3
		Over surface	6 kV level 3
Radiated RF	According to EN61000-4-3	80 MHz to 2 GHz	10 V/m level 3
Immunity to fast transient bursts	According to EN61000-4-4	Power supply	2 kV level 3
		Communication	1 kV level 3
Immunity to radioelectric fields	According to EN61000-4-6		10 V rms level 3
Surge immunity	According to IEC/EN 61000-4-5	Line to earth/ground	1 kV (2 Ω/18 μF) level 3
		Line to line	2 kV (2 Ω/18 μF) level 3

Physical Characteristics

Dimensions	117 x 70 x 55 mm (4.61 x 2.76 x 2.17 in.)	
Mounting	<ul style="list-style-type: none"> ● Mounted by 1 spring-clip (supplied) for panels 0.8 to 6 mm (0.03 to 0.23 in.) thick ● Cut-out dimensions: 45 x 92 mm (1.77 x 3.62 in.) 	
Display unit	Type	Backlight LCD
	Backlight	Continuous
	Electrical life with backlight on	70,000 h
Signaling	4 LEDs	
Connection	Front port	RJ45 female (unshielded)
	Rear port	RJ45 female (unshielded)

Chapter 2

Installing the LTM CU Control Operator Unit

Overview

This chapter describes the physical installation and assembly of the LTM CU Control Operator Unit. It also explains how to connect and wire the LTM CU to the LTM R controller or to a PC.

What Is in This Chapter?

This chapter contains the following topics:

Topic	Page
LTM CU Dimensions	16
Inserting the Local Control Interface Label	17
Flush Mounting the LTM CU	19
Mounting a Portable LTM CU	21
Connecting the LTM CU	23

LTM CU Dimensions

LTM CU Dimensions

The dimensions of the LTM CU are shown below:

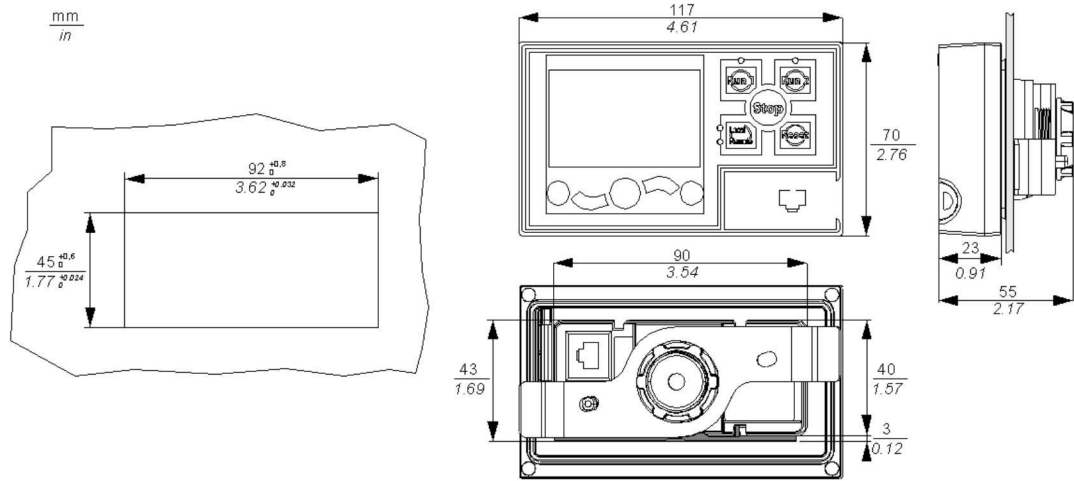

Inserting the Local Control Interface Label

Overview

The local control interface is the part of the LTM CU that contains the 5 control keys and 4 LEDs. To identify these different elements, you can choose:

- one of the pre-defined labels,
- the blank label that you can customize with a pen.

The diagram below shows an example of a pre-defined label:

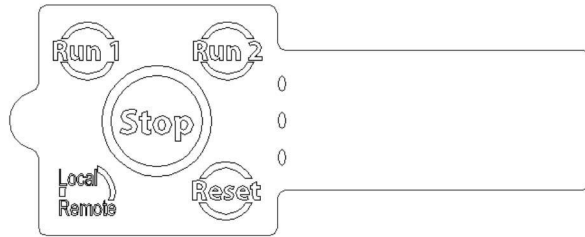

NOTE: The label must be chosen according to the LTM R controller's operating mode. The keys' label on the local control interface must be appropriate to the functions of the LTM R operating mode.

Inserting Labels

To insert a local control interface label:

Step	Action
1	Slide the tip of the label into the slit on the side of the LTM CU as shown below. Be careful to use the right slit as shown in the zoom below. <div data-bbox="539 1017 1161 1350" data-label="Image"> </div>
2	Slide the rest of the label into position in the LTM CU, making sure that the identifiers on the label are correctly aligned with the interface elements: <div data-bbox="571 1459 1134 1729" data-label="Image"> </div>

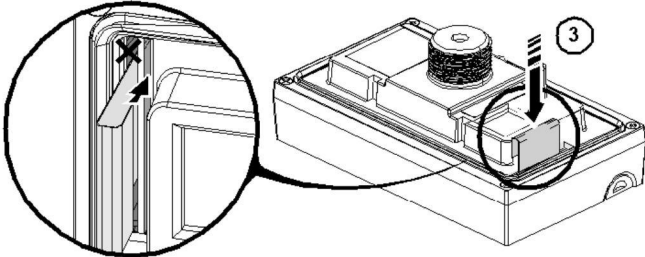
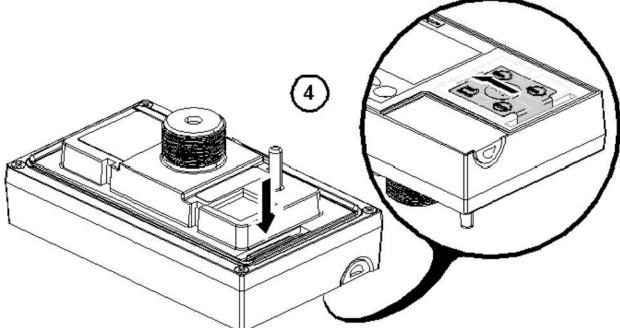
Step	Action
3	<p>Tuck the label tab into the tab loop, as shown in the diagram below:</p> 
4	<p>Push the tab into place so it lies flat against the loop:</p> 

Flush Mounting the LTM CU

Overview

This section describes how to mount the LTM CU inside a panel cut-out, as well as the accessories needed for mounting.

LTM CU Rear Face

The various elements of the rear face of the LTM CU are shown in the diagram below:

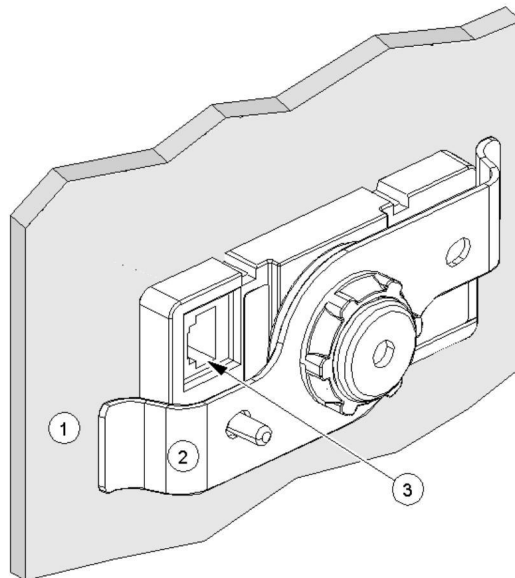

- 1 Mounting fixation (with mounting nut)
- 2 Clamp
- 3 Rear RJ45 port

Panel Setup Procedure

Stage	Description
1	Check that the installation panel or cabinet's surface is flat, in good condition, and has no jagged edges. Metal reinforcing strips can be attached to the inside of the panel, near the panel opening, to increase the panel's rigidity.
2	Panel thickness should be from 0.8 to 6 mm (0.03 to 0.23 in.).
3	Be sure that the ambient operation temperature and the ambient humidity are within their designated ranges. (When installing the LTM CU in a cabinet or enclosure, the ambient operation temperature is the cabinet or enclosure's internal temperature.)
4	Be sure that heat from surrounding equipment does not cause the LTM CU to exceed its standard operating temperature (see page 13).
5	When installing the LTM CU in a slanted panel, the panel face should not incline more than 30°. <div style="text-align: center;"> </div> <p>When installing the LTM CU in a slanted panel, and the panel face inclines more than 30°, the ambient temperature must not exceed 40 °C (104 °F).</p>

Mounting the LTM CU

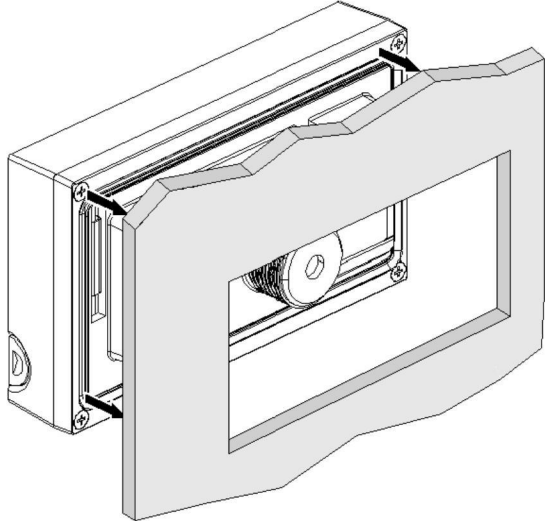
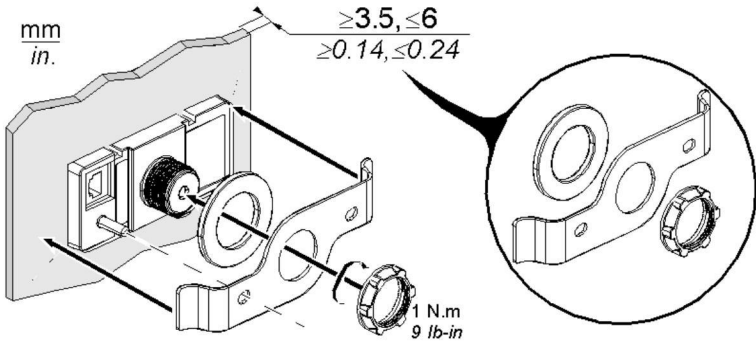
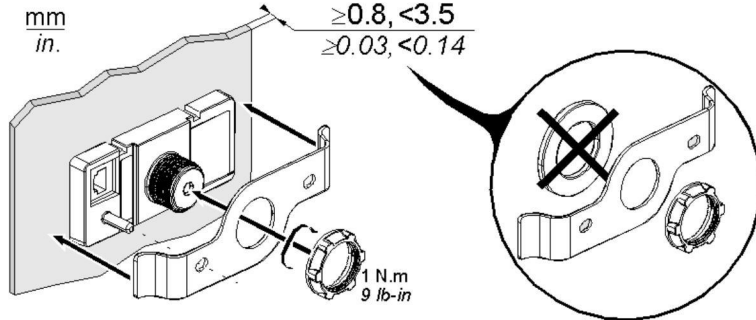
Step	Action
1	Cut an opening of 45 x 92 mm (1.77 x 3.6 in.) into the panel.
2	Insert the unit into the panel cut, as shown below: 
3	As shown below, position the metallic washer only if the panel thickness is more than 3.5 mm (0.14 in.). Position the clamp in place, then insert the mounting nut and tighten. If the mounting nut is not correctly attached, the unit may shift or fall out of the panel: To open and lock the mounting nut, use the special tool No. ZB5 AZ905, if needed. <div style="display: flex; flex-direction: column; align-items: center;"> <div style="display: flex; align-items: center; margin-bottom: 20px;"> <div style="text-align: center; margin-right: 10px;"> $\frac{\text{mm}}{\text{in.}}$ </div> <div style="text-align: center; margin-right: 10px;"> $\geq 3.5, \leq 6$ $\geq 0.14, \leq 0.24$ </div>  </div> <hr style="border-top: 1px dashed gray;"/> <div style="display: flex; align-items: center;"> <div style="text-align: center; margin-right: 10px;"> $\frac{\text{mm}}{\text{in.}}$ </div> <div style="text-align: center; margin-right: 10px;"> $\geq 0.8, < 3.5$ $\geq 0.03, < 0.14$ </div>  </div> </div>

Mounting a Portable LTM CU

Overview

You may need to move your LTM CU from one place to another. To do so, use the kit (reference LTM9KCU) equipped with magnets, which turns the LTM CU into a portable device. Then, position the kit on a metallic surface.

This section describes how to mount an LTM CU into the kit and how to remove it.

LTM9KCU Kit Characteristics

- The kit consists of a casing, made of 2 symmetrical parts.
- No tools are required to mount or remove the LTM CU from the casing.
- 4 magnets, at the back of the kit, let you position the LTM CU on any metallic surface.
- For your convenience, you can move the kit together with its connection cable using the cable housing on the rear face of the casing.

Mounting the LTM CU into the LTM9KCU Kit

To mount the LTM CU into the kit:

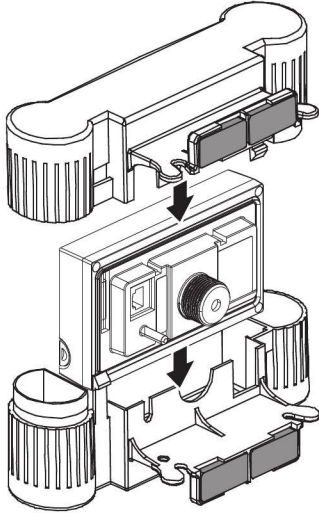
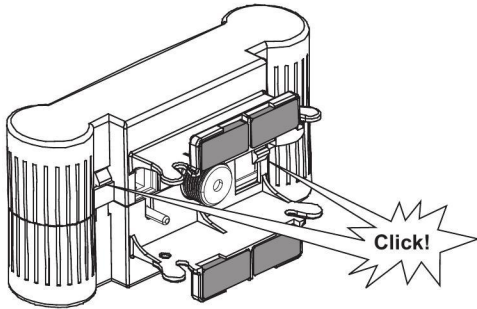
Step	Action
1	Position the LTM CU between the 2 parts of the casing. 
2	Press the 2 parts until you hear a click. 

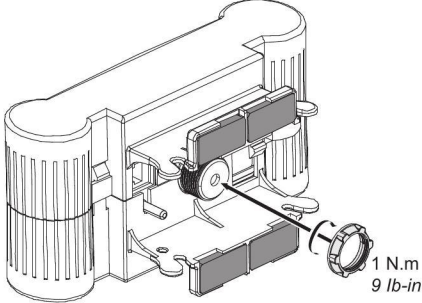
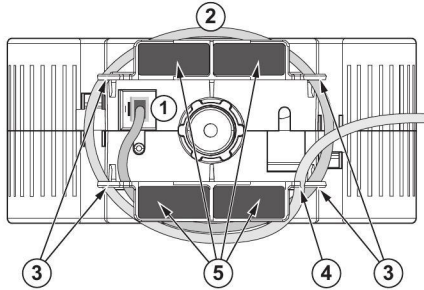
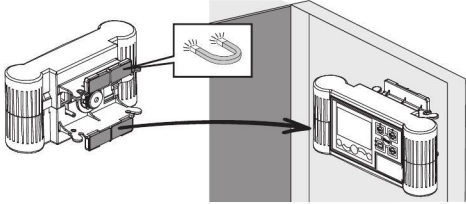
Step	Action
3	<p>On the rear face of the LTM CU, insert the mounting nut and tighten to 1 N•m (9 lb-in).</p>  <p>NOTE: Do not use the clamp which is part of the mounting fixation elements contained in the LTM CU box.</p>
4	<p>Connect the communication cable between the LTM CU and the LTM R controller on the RJ45 port. Wind the cable into the kit winding:</p> <ul style="list-style-type: none"> • Start winding the cable anti-clockwise, ensuring the cable goes behind the 4 legs that are on the edge of the 4 magnets. • On the last turn, use the slot on the lower right part of the casing to block the cable end. <p>NOTE: The cable housing allows for a 1 m (3.3 ft) maximum cable length.</p>  <p>1 RJ45 port 2 Communication cable 3 Legs (4) 4 Slot (to block the cable end) 5 Magnets</p>
5	<p>The magnets of the LTM9KCU kit enable the kit to be positioned on a metallic surface.</p> 

Removing the LTM CU from the LTM9KCU Kit

To remove the LTM CU from the kit:

Step	Action
1	Unwind the cable (if required), and disconnect it from the RJ45 port.
2	Unscrew the mounting nut.
3	Draw apart the two parts of the casing, and extract the LTM CU.

Connecting the LTM CU

Overview

After you have mounted the LTM CU, you must connect it to the HMI interface port (RJ45) on the LTM R controller, or on the LTM E expansion module. You can also connect a PC to the LTM CU front face port. This section describes how to connect the LTM CU to both the LTM R and a PC.

Wiring Rules

The following wiring rules must be respected in order to reduce disturbance on the behavior of the LTM CU due to EMC:

- Keep as large a distance as possible between the communication cable and the power and/or control cables (minimum 30 cm or 11.8 in.).
- Cross over different types of cables at right angles, if necessary.
- Do not bend or damage the cables. The minimum bending radius is 10 times the cable diameter.
- Avoid sharp angles of paths or passages of the cable.
- The cable shield must be connected to a protective ground at both ends.
- The connection of the cable shield must be as short as possible.
- Several shields can be connected together.
- Perform the grounding of the shield with a collar.
- Place the cable along the grounded plate around the withdrawable drawer.

NOTICE

UNINTENDED EQUIPMENT OPERATION

Use Schneider Electric standard cables.

Failure to follow these instructions can result in equipment damage.

Communication and Power Supply

The LTM CU connects to the LTM R controller via the RJ45 port at the rear of the unit (see *Connecting to the LTM R Controller*, page 24). This connection is used to provide both the communication signals and the power supply.

Connecting Cables and RJ45 Pinout

To connect the LTM CU and the LTM R controller, use the specific cables LTM9CU10 and LTM9CU30. The LTM CU RJ45 port pinout is shown below:

Front view

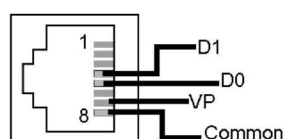

Pin no.	Signal	Description
1	Reserved	Do not connect
2	Reserved	Do not connect
3	Reserved	Do not connect
4	D1 or D(B)	Communication between LTM CU and LTM R controller
5	D0 or D(A)	Communication between LTM CU and LTM R controller
6	Reserved	Do not connect
7	VP	+7 Vdc power supply provided by the LTM R controller
8	Common	Signal and power supply common

Connecting to the LTM R Controller

The diagrams below show the LTM CU connected to the LTM R controller, with and without the LTM E expansion module:

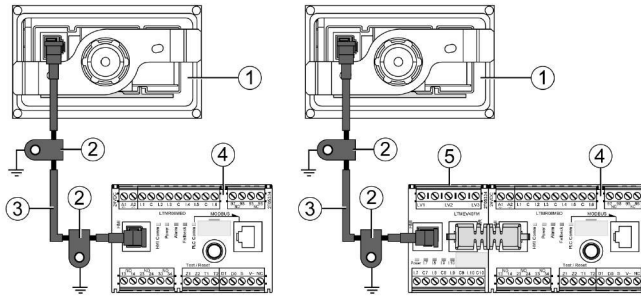

- 1 LTM CU Control Operator Unit
- 2 Grounding collar
- 3 LTM9CU•• HMI device connection cable
- 4 LTM R controller
- 5 LTM E expansion module

Power up

When the LTM CU has been connected to the LTM R controller, it powers up and performs a series of self-tests. During this time, the LCD display lights up and firmware version and language versions inside the LTM CU are displayed for a few seconds. After a successful connection, the backlight changes to the setting in LTM R and the main menu appears.

Connecting to a PC

You can connect a PC to the LTM CU via the RJ45 on the front face of the unit, as shown in the diagram below.

The diagrams below show the connections from a PC to the LTM CU and the LTM R controller, with and without the LTM E expansion module:

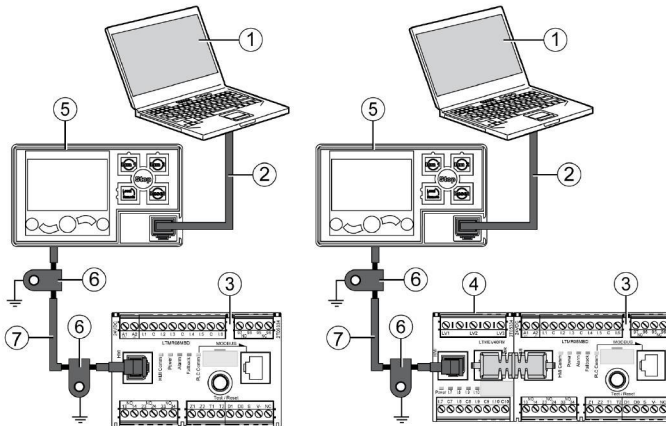

- 1 PC running SoMove with the TeSys T DTM
- 2 Cable kit TCSMCNAM3M002P
- 3 LTM R controller
- 4 LTM E expansion module
- 5 LTM CU Control Operator Unit
- 6 Grounding collar
- 7 LTM9CU•• HMI device connection cable

When the LTM CU is connected to a PC, the LTM CU becomes passive and cannot be used to visualize information.

Chapter 3

Language Management

Introduction

This chapter describes how to use the LTMCU Langtool language management software.

Use LTMCU Langtool to change the language stored in the LTM CU when you need the LTM CU to display other languages than those stored in the embedded dictionary.

What Is in This Chapter?

This chapter contains the following topics:

Topic	Page
Presentation of LTMCU Langtool	26
Using LTMCU Langtool	28

Presentation of LTMCU Langtool

Overview

The LTM CU embedded dictionary can store up to 3 languages.

The default (factory) displayed language is English. You can change

- the 2 other stored languages,
- the English version.

To make these changes of language or version, you have to download language files to the LTM CU with a PC running the LTMCU Langtool language management software.

A language file contains a dictionary version of 1 language.

The LTMCU Langtool and language files can be downloaded from the Schneider Electric website (www.schneiderelectric.com).

LTMCU Langtool Software

LTMCU Langtool is a software dedicated to downloading language files to the LTM CU.

LTMCU Langtool:

- is a Microsoft® Windows® 2000/XP/7-based application,
- runs on a PC,
- enables the LTM CU to display information in several languages.

Language Files

The language files have a name structured as follows: LTMCU_ccV_XXXX.ini.

Example:

LTMCU_en0_1300.ini is the language file for the English (en) version.

Character	Description
cc	2-letter code of the language concerned (in lower case) following ISO 639 international standards
V	1 digit for the language variant (0 for basic language)
XXXX	4 digits for version of the language concerned

Downloading from the Website

The procedure below describes how to download to a PC:

- the LTMCU Langtool program file,
- language files.

Step	Action
1	Connect your PC to our website www.schneider-electric.com .
2	In the Search field, type TeSys T .
3	Click Product Offer .
4	Click TeSys T .
5	On the TeSys T product offer page, click on Download / Documents & Softwares .
6	Click Software/Firmware .
7	Download to your PC: <ul style="list-style-type: none">• the <i>LTMCU Langtool Software</i>• the <i>LTMCU_languages</i> file.

Processing the .zip file

The procedure below describes how to process the downloaded file so that LTMCU Langtool is ready for use:

Step	Action
1	In your Microsoft® Windows® file manager, unzip <i>landown_vxxx.zip</i> to a local directory using a decompression tool. The directory contains the root files including <i>Startup.exe</i> .
2	In your Microsoft® Windows® file manager, unzip <i>LTMCU_languages_xxx.zip</i> to a local directory using a decompression tool. The directory contains the available *.ini language files.

Using LTMCU Langtool

Process Description

The table below describes the steps to follow to download language files to the LTM CU with a PC running the LTMCU Langtool language management software.

Phase	Description
1	Connect the LTM CU to your PC: see <i>Connecting the LTM CU</i> , page 23. The LTM CU must be connected to the LTM R.
2	Start LTMCU Langtool.
3	Configure LTMCU Langtool.
4	Read data about languages stored in the LTM CU.
5	Select languages from the <i>Language</i> folder.
6	Download selected languages to the LTM CU.
7	Read again the language data to verify that the correct languages are properly stored in the LTM CU.
8	Close LTMCU Langtool.

NOTE: In this process, the *Language* folder refers to the folder located in the LTMCU Langtool local directory, see *Downloading from the Website*, page 26.

Starting LTMCU Langtool

The procedure below describes how to start LTMCU Langtool.

Step	Action
1	Double-click the <i>Startup.exe</i> file from the LTMCU Langtool local directory.
2	Select the LTM CU firmware version and click Done .
3	Select a view language and click Done . This language will be used for the dialog boxes of LTMCU Langtool on your PC.

Configuring LTMCU Langtool

The procedure below describes how to configure LTMCU Langtool.

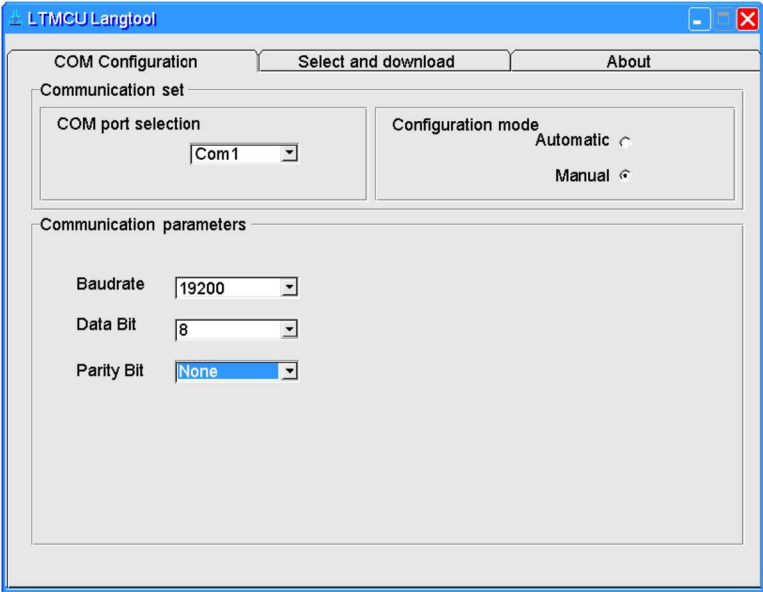
Step	Action
1	Select the COM Configuration tab. 

Step	Action
2	Click the COM port selection arrow to select the PC communication port connected to the LTM CU. To know the virtual communication port assigned on the PC, when using the TCSMCNAM3M***P cable: <ol style="list-style-type: none"> 1 Open Device Manager in Windows 2 Expand Ports (COM & LPT) 3 Read the number of the assigned LTM CU virtual communication port.
3	Select the Configuration mode : <ul style="list-style-type: none"> ● Automatic: the Communication parameters are set automatically and the configuration of LTM CU Langtool is then finished. ● Manual: the communication parameters must be set.
4	In Manual configuration mode only, set the communication parameters : <ul style="list-style-type: none"> ● Baudrate ● Data Bit ● Parity Bit
5	Click the Select and download tab to access the functionalities of LTM CU Langtool.

LTM CU Langtool Functionalities

The diagram below shows the **Select and download** tab of LTM CU Langtool and the functionalities of the 3 areas in this tab.

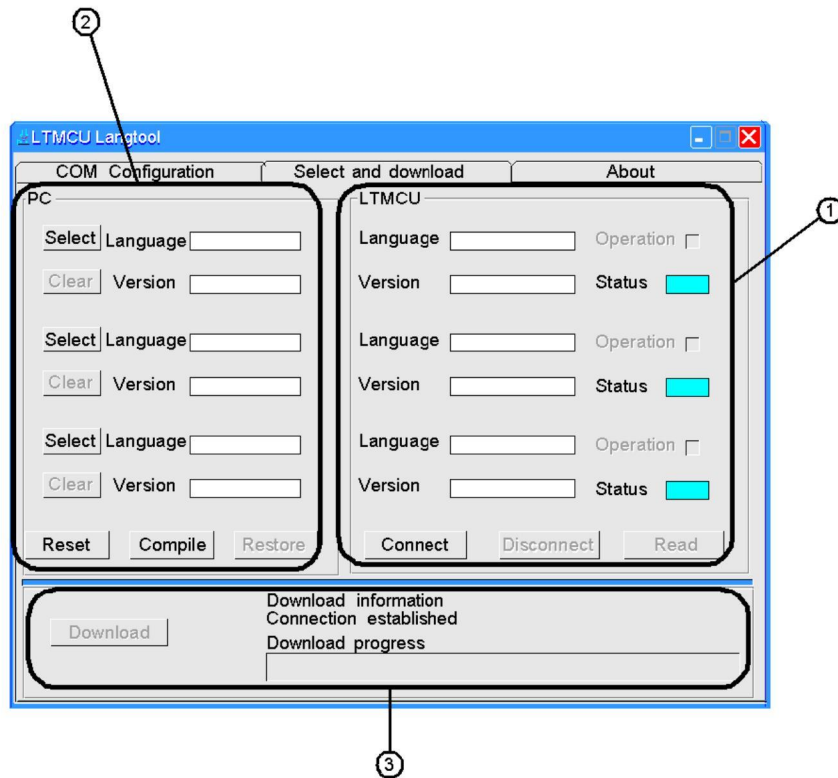

Area	Functionality
1	The LTM CU area is dedicated to: <ul style="list-style-type: none"> ● reading data about languages stored in the LTM CU, ● enabling and disabling languages stored in the LTM CU.
2	The PC area is dedicated to: <ul style="list-style-type: none"> ● select the languages to download to the LTM CU from the LTM CU Langtool <i>Language</i> folder.
3	The Download area is dedicated to: <ul style="list-style-type: none"> ● downloading languages from your PC to the LTM CU.

Reading Data about Languages





The procedure below describes how to read and display data on the languages stored in the LTM CU. Use the **LTM CU** area of the **Select and download** tab.

Step	Action	Result
1	Select the Select and download tab.	
2	Click Connect .	Your PC can communicate with the LTM CU. An hour glass appears on the LTM CU display. It remains displayed until you click Disconnect in the LTM CU area.
3	Click Read to display the data about the languages stored in the LTM CU.	The following data is displayed in a block for each language: <ul style="list-style-type: none"> ● Language ● Version ● Status and Operation Example of a block: <div style="border: 1px solid gray; padding: 5px; margin: 10px 0;"> Language <input type="text" value="English"/> Operation <input checked="" type="checkbox"/> Version <input type="text" value="1"/> Status </div> 1 or 2 blocks, except the top block, may remain empty.

Language Status and Operation



The table below describes:

- the 4 possible states for a language stored in the LTM CU,
- the use of the **Operation** checkbox.

Color	Status	Operation Checkbox
 green	Language is downloaded in the LTM CU and has been enabled (Operation checkbox checked).	Uncheck Operation to disable it.
 yellow	Language is downloaded in the LTM CU and has been disabled (Operation checkbox unchecked).	Check Operation to enable it.
 dark blue	Language has been downloaded in the LTM CU and has been removed after 7 check/uncheck actions on the Operation checkbox.	Operation checkbox not available. Download this language to the LTM CU if you want to enable it again.
 light blue	Language not properly downloaded in the LTM CU or no language in the LTM CU.	Operation checkbox not available. Download this language to the LTM CU if you want to enable it again.

Select Languages in the Language Folder

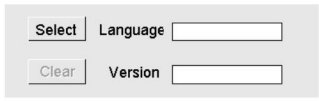
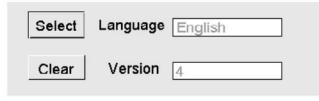
The procedure below describes how to select in the Language folder the languages to download to the LTM CU. Use the **PC** area of the **Select and download** tab.

Step	Action	Result
1	Select the Select and download tab.	The PC area is divided into 3 blocks.  Each block is dedicated to one of the languages you want to download into the LTM CU.
2	Click Select in a block.	The file folder opens.
3	Browse and open the right file in the <i>Language</i> folder. Language 1 must be English, but you can select the version. Language 2 and 3 may remain empty.	Your selection is displayed in the block: <ul style="list-style-type: none"> ● Language ● Version (language dictionaries are likely to evolve) 
4	Click Clear if you want to remove the selection in this block. Then go back to step 2.	
5	Once the languages are selected, click Compile to check the set of languages to download to the LTM CU.	Compiling lasts a few seconds until the "set complete" window displays. 
6	Click OK .	Your set of languages is ready to be downloaded to the LTM CU.
7	Perform one of the following actions: <ul style="list-style-type: none"> ● download the set of languages (see page 32). ● click Reset and go back to step 2. ● click Clear for any language and go back to step 2. If you accidentally cleared a language, click Restore to avoid returning to step 2. 	Selection of languages downloaded.

Example

The graphic shown below represents the **Select and download** tab of LTMCU Langtool.

In this example, a set of languages is ready to be downloaded to the LTM CU. The user has already:

- read (in the 3 blocks of the **LTM CU** area) data about languages stored in the LTM CU,
- selected (in the 3 blocks of the **PC** area) the languages to download to the LTM CU.

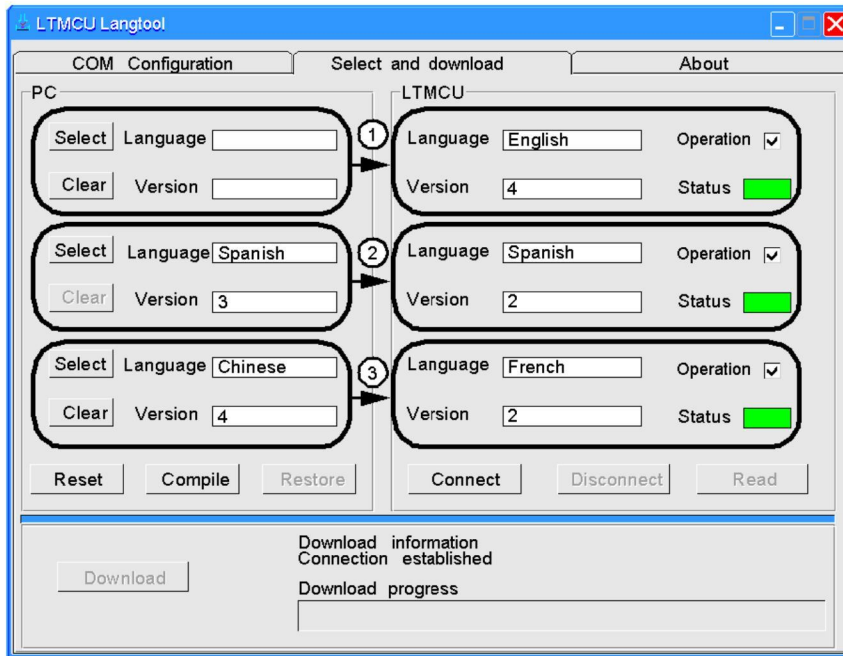

- 1 No change for English.
- 2 Spanish upgrade to a more recent version.
- 3 French version 2 replacement by Chinese version 4.

Download, Check and Close

The procedure below describes how to download the set of languages to the LTM CU. Use the **Download** and **LTM CU** areas.

Step	Action	Result
1	Click Download to transfer the language files.	When a block in the PC area is empty, the language stored in the LTM CU (opposite block in the LTM CU area) will not be changed. A popup window indicates that downloading is complete.
2	Click Read to check the languages stored in the LTM CU.	The status of downloaded languages must be green. If it is not the case, select again languages in the <i>Language</i> folder and download them again.
3	Click Disconnect to close the communication with the LTM CU.	You can disconnect your PC from the LTM CU.
4	Click to quit LTMCU Langtool.	You are ready to select the language displayed by the LTM CU: see <i>Selecting the Language Displayed by the LTM CU</i> , page 50.

NOTE: Download time is approximately 5 minutes for each language.

Chapter 4

Using the LTM CU Control Operator Unit

Overview

This chapter describes how to use the LTM CU Control Operator Unit to configure and monitor LTM R controller parameters.

What Is in This Chapter?

This chapter contains the following topics:

Topic	Page
LTM CU Physical Description	34
Parameter Display	37
Quick View Display	39
Detected Faults and Warnings Display	41
Using the Local Control Interface	42
Navigating the Menu Structure	45
Editing Values	46
Password Access	49
Selecting the Language Displayed by the LTM CU	50
First Setup Menu	51
Main Menu	52
Menu - Metering Setting	53
Menu - Protection Setting	54
Menu - Control Setting	58
Menu - Services	60

LTM CU Physical Description

Front Face

The front face of the LTM CU is shown below:

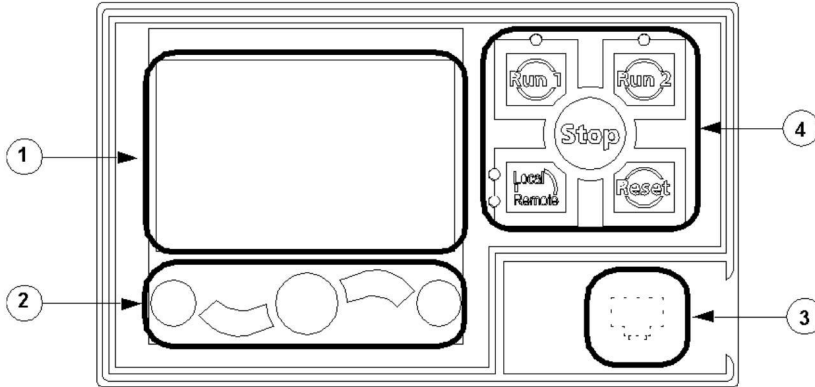

- 1 LCD display
- 2 Contextual navigation keys
- 3 Front face RJ45 port for PC connection (covered)
- 4 Local control interface, including 5 control keys and 4 LEDs

For a detailed description of:

- the LCD display and contextual navigation keys: see below.
- the control panel interface: see *Using the Local Control Interface*, page 42.
- the RJ45 port: see *Connecting the LTM CU*, page 23.

Navigation Keys

The LTM CU navigation keys are contextual, that is, their function depends on the associated icons shown on the LCD display. These icons change for different displays, so the navigation key functions also change.

The navigation keys can be used to:

- navigate menus and sub-menus,
- scroll within a value list,
- select a setting in a value list,
- exit a value list without making a selection,
- return to the main (first-level) menu,
- switch between manual and automatic presentation mode in Quick View display.



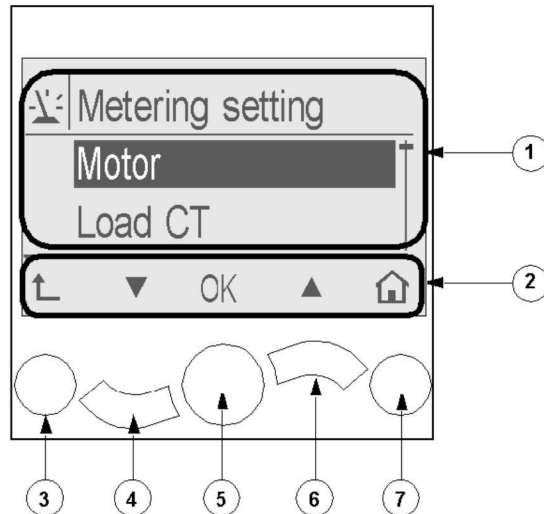







The diagram below shows an example of the different functions of each of the navigation keys associated with an icon on the LCD display:



- 1 Information area of the LCD display
- 2 Contextual navigation icons area of the LCD display
- 3 Move up to the next higher-level menu
- 4 Move down to the next item in the menu
- 5 Select an item
- 6 Move up to the previous item in the menu
- 7 Return to the main menu

















Contextual Navigation Icons

The following table describes the icons used with the contextual navigation buttons on the LTM CU:

Icon	Description	Icon	Description
	Enables access to the main menu from a sub-menu or from Quick View		Enables access to Quick View from the main menu or a sub-menu
	Scroll down		Enables access to manual scroll mode (when Quick View is in automatic scroll mode)
	Scroll up		Enables access to automatic scroll mode (when Quick View is in manual scroll mode)
	Validates a setting or value and enables access to a sub-menu when a menu is selected		Used to increment a setting in menu mode
	Move up to the next higher-level menu		Used to decrement a setting in menu mode
	When a menu item is password-protected, this icon enables access to the Enter Password screen		

Information Icons

The following table describes the icons provided as information in the information area of the LCD display. They indicate, among others, the selected menu or parameter.

Icon	Description	Icon	Description
	Main menu		Indicates that the present display is Quick View
	Metering setting menu		Indicates that a detected warning has occurred
	Protection setting menu		Indicates that an error has been detected
	Control setting menu		Information
	Services menu		Check box selected
	Language selection menu		Check box unselected
	Radio button selected		Item has been selected (for inclusion in Quick View display)
	Radio button unselected		LTM R in Configuration mode

LCD Displays

The LTM CU presents 3 different LCD displays:

LCD display	Functions
Menu	<ul style="list-style-type: none"> • Displaying and editing the configuration settings required for configuring the LTM R (metering, protection, control and services settings) • Displaying diagnostic and history data
Quick View	<ul style="list-style-type: none"> • Displaying real-time metering of pre-selected parameters by automatic or manual scrolling
Detected Faults and Warnings	<ul style="list-style-type: none"> • Displaying the most recent detected fault or warning

Each of these 3 displays is described in detail below.

LCD Display Settings

- The LCD display is continuously backlit.
- Contrast and Brightness are adjustable by using the Services menu.

Parameter Display

Overview

The LTM R parameters are contained in 2 different menu structures:

- the main menu and sub-menus
- the First setup menu

The navigation and sub-menu presentation are identical in the 2 menu structures. Each sub-menu consists of one or several levels of nested parameters.

The main menu appears

- on power-up of the LTM CU after the First setup menu settings have been saved, if no faults or warnings are detected, or
- by pressing the  button.

The main menu consists of 5 sub-menus: Metering setting, Protection setting, Control setting, Services, and Language. You can access each of these sub-menus from the main menu.

The First setup menu enables to set a limited number of configuration parameters of the LTM R, see *First Setup Menu*, page 51.

Main Menu Display

The following diagram shows the elements in the main menu display:

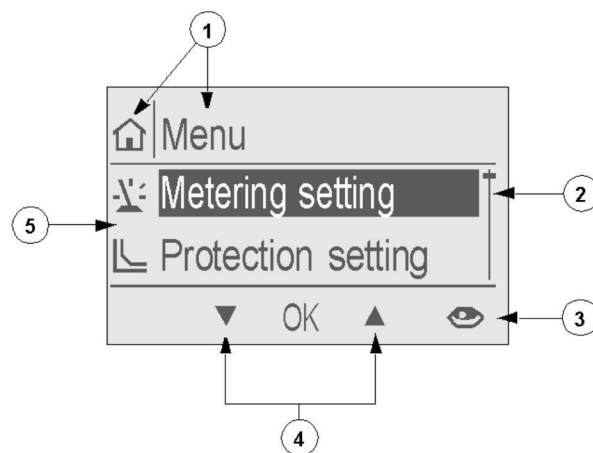

- 1 Main menu icon and title
- 2 Scroll bar, indicating level in the main menu
- 3 Short key to Quick View display (from main menu only)
- 4 Contextual menu navigation keys
- 5 Display area, with list of sub-menus identified by icon and title

Sub-Menu Display

The following diagram shows an example of a sub-menu display:

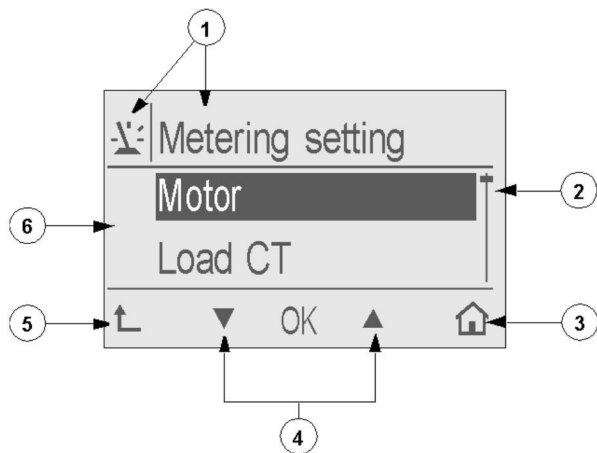

- 1 Menu icon and title
- 2 Scroll bar, indicating level in sub-menu
- 3 Short key to main menu
- 4 Contextual menu navigation keys
- 5 Return to higher-level menu key
- 6 Display area, with list of sub-menus

First Setup Display

The following diagram shows the First setup menu display:

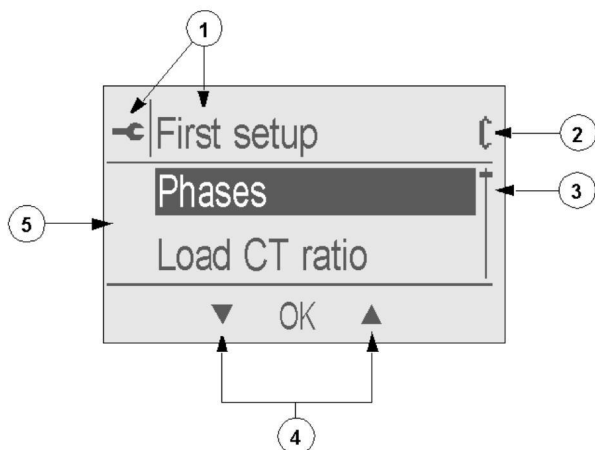



- 1 First setup menu icon and title
- 2 Configuration mode icon
- 3 Scroll bar, indicating level in the First setup menu
- 4 Contextual menu navigation keys
- 5 Display area with list of accessible parameters

Quick View Display

Overview

The Quick View display contains a scrolling list of dynamically changing values for pre-selected variables. Select the variables you want to display using the Services menu (see *Menu - Services, page 60*).

The Quick View is displayed:

- manually, by selecting  in the main menu,
- automatically, after the main menu has been displayed for 10 seconds with no key pressed, or
- by pressing  to close a detected fault or warning display.

There are 2 types of Quick View display modes: automatic scroll mode and manual scroll mode. You can switch from one to the other by pressing contextual navigation keys.

Automatic Scroll Mode

The following screen shows a Quick View display in automatic scroll mode. In this mode, each variable is displayed for a few seconds at a time.

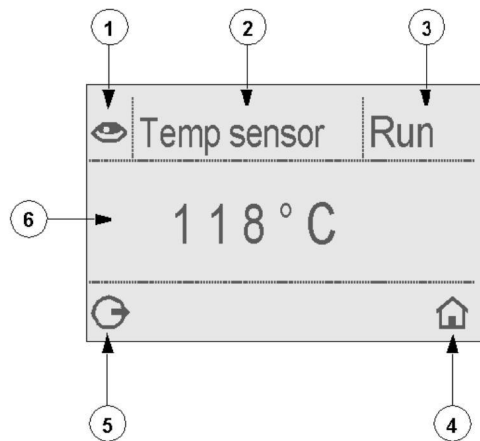

- 1 Quick View display icon
- 2 Name of the variable currently displayed
- 3 Motor state
- 4 Short key to main menu
- 5 Access to manual scroll mode by pressing the associated contextual navigation key
- 6 Value of the variable currently displayed

Manual Scroll Mode

The following screen shows a Quick View display in manual scroll mode. In this mode, you can scroll through the list of variables using the contextual navigation keys.

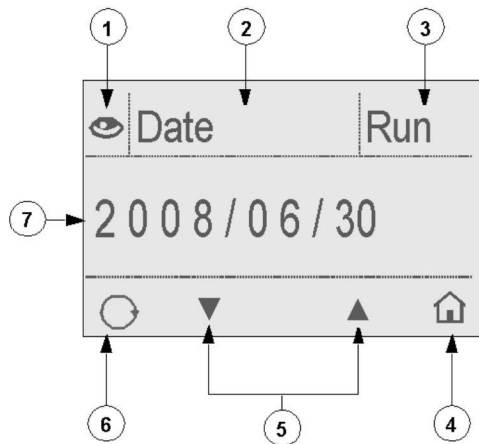

- 1 Quick View display icon
- 2 Name of the variable currently displayed
- 3 Motor state
- 4 Short key to main menu
- 5 Contextual navigation keys; pressing them scroll to the next or previous variable in the Quick View
- 6 Access to automatic scroll mode by pressing the associated contextual navigation key
- 7 Value of the variable currently displayed

Detected Faults and Warnings Display

Overview

The Detected Faults and Warnings display contains a description of the most recently detected fault or warning.

The Detected Faults and Warnings display opens automatically upon the detection of a fault or warning.

Detected Faults and Warnings Display

The following diagram shows the elements in the Detected Faults and Warnings display:

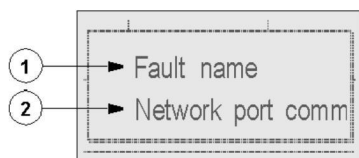

- 1 Text indicating whether a detected fault or warning is displayed
- 2 Name of the detected fault or warning currently displayed

Closing Detected Faults and Warnings Display

The Detected Fault and Warnings display is:

- automatically closed after acknowledgement of the detected fault or warning, that is:
 - for a detected warning: automatic acknowledgement when the associated real-time parameter value conditions are no longer satisfied
 - for a detected fault: acknowledgement on your initiative by operating a reset (LTM R or communication reset)
- temporarily closed on your initiative by pressing  and navigating the menus. After a few seconds, it will appear again.

Using the Local Control Interface

Overview

The Local Control Interface consists of 5 control keys and 4 LEDs. The control keys, if active, enable you to control the LTM R. Pressing a control key sends a signal to the LTM R to activate the associated function.

The 4 LEDs provide information about the LTM R state. These LEDs are driven from the LTM R and are not related to the LTM CU state.

Control Key Functions

The label on each of the control keys depends on the label set you have inserted (see *Inserting the Local Control Interface Label*, page 17).

⚠ WARNING

UNINTENDED EQUIPMENT OPERATION

Proper labeling of the control keys must be validated.

Failure to follow these instructions can result in death, serious injury, or equipment damage.

In order to explain the function of each control key, in the diagram below, the 5 control keys are labeled 1 to 5:

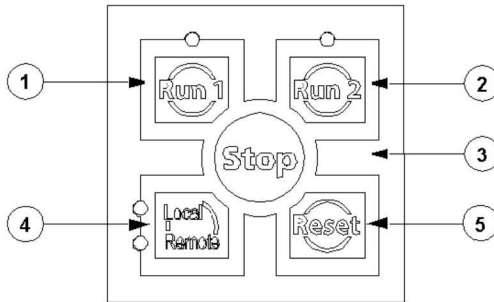

Control keys 1 to 3 are used to control LTM R outputs O.1 and O.2. The function of control keys 1 to 3 depends on the motor operating mode. The following table lists their functions for each operating mode:

Operating Mode	Assignment	Key 1	Key 2	Key 3
Overload	2-wire (maintained)	No action	No action	No action
	3-wire (impulse)			
Independent	2-wire (maintained)	Control motor (O.1)	Control O.2	Stop motor (open O.1) and open O.2 while pressed
	3-wire (impulse)	Start motor (close O.1)	Close O.2	Stop motor (open O.1) and open O.2
Reverser	2-wire (maintained)	Forward run	Reverse run	Stop while pressed
	3-wire (impulse)	Start motor forward	Start motor reverse	Stop motor
Two-step	2-wire (maintained)	Control motor	No action	Stop while pressed
	3-wire (impulse)	Start motor	No action	Stop motor
Two-speed	2-wire (maintained)	Low speed control	High speed control	Stop while pressed
	3-wire (impulse)	Low speed start	High speed start	Stop motor

For more information about operating mode and output assignments, see the *TeSys® T LTM R Motor Management Controller User's Manual*.

The functions of control keys 4 and 5 are stable and do not depend on the operating mode. The following table describes the functions of control keys 4 and 5:

Control Key	Description
Key 4	Switch between local and remote mode.
Key 5	Reset the LTM R controller and clear all detected faults that can be reset.

Active/Inactive Control Keys

Control keys 1 to 5 are active or inactive according to the selected active control source. The following table describes the state of control keys 1 to 5 for each case:

Control Key	The LTM CU channel...	
	is the active control source	is not the active control source
1	Active	Inactive
2	Active	Inactive
3	Active	<ul style="list-style-type: none"> 2-wire: inactive 3-wire: active if the value of the Stop HMI Disable parameter = 0 (Stop HMI key is enabled)
4	Depending on the value of the Control Remote Local Buttons Enable parameter: <ul style="list-style-type: none"> parameter = 0 (disable): key is inactive parameter = 1 (enable): key is active 	
5	Active	

LEDs

In the diagram below, the 4 control LEDs are labeled A - D:

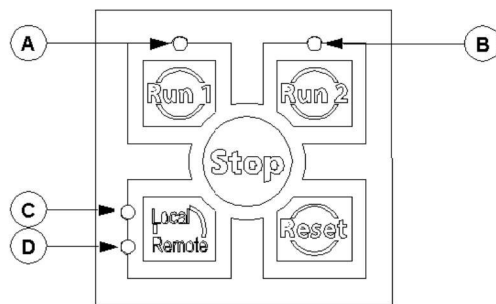

The following table describes each of the 4 LEDs:

LED	When active, indicates that:	Color
A	Output O.1 is active (see the functional description for control key 1 above)	Red or green
B	Output O.2 is active (see the functional description for control key 2 above)	Red or green
C	The active control source is the local source	Amber
D	The active control source is the remote source	Amber

You can choose whether the LEDs A and B are red or green when active by setting the Run LED color parameter in the Services sub-menu. See *HMI Setting*, page 60.

Active Control Source

The LTM CU can be configured as the local or remote active control source.

- The LTM CU is the active local control source when the parameter Control local channel setting is set to HMI.
- The LTM CU is the active remote control source when the parameter Control remote channel setting is set to HMI.
- The key 4 allows to switch between local and remote control mode if the logic input I.6 is **ON** and the parameter HMI remote local buttons enable is set to **Yes**.

The parameters are available from the sub-menu Control Settings / Remote/Local. See *Remote/Local*, page 58 in the Control Setting Menu.

The table below indicates if the keys are active or not depending on the LTM CU active source status and the color of the Local / Remote LEDs:

If LTM CU is...	and if...	Then the keys are...
the local active source	LED C is ON (amber)	active
	LED D is ON (amber)	inactive
the remote active source	LED C is ON (amber)	inactive
	LED D is ON (amber)	active

Example

The following example explains the meaning of LED C and D state to know whether keys 1 and 2 are active or not.

If the 2 following conditions are satisfied:

- Control local channel setting parameter is set to HMI (in this example: HMI = LTM CU)
- I.6 input is active (for example in case of a strap between C and I.6 inputs on the LTM R plug-in terminal)

Then the HMI is the local control channel and keys 1 and 2 are active / inactive according to LED C and D state:

- LED C **ON** and LED D **OFF** means that the LTM CU is the active control source: keys 1 and 2 are active
- LED C **OFF** and LED D **ON** means that the LTM CU is not the active control source: keys 1 and 2 are inactive.

Navigating the Menu Structure









Overview

When the LTM CU is powered up:

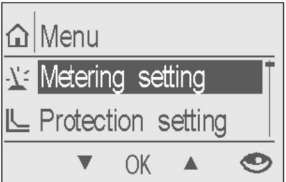
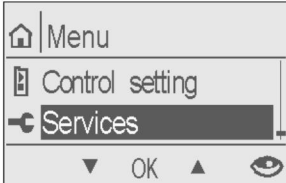
- The First setup menu is displayed when LTM R commissioning was not done.
- The detected fault and warning display is executed if the LTM R is in a detected fault and warning condition.
- The Quick View is displayed in other cases. Back to main menu by  button.

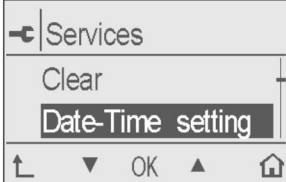
Navigating Menus and Sub-menus

The example below shows how to navigate the menu structure to display the date and time settings:

Step	Description	Screen Display
1	If necessary, press  on the right to access the main menu (shown here). Press  to scroll down to other menu choices.	
2	When the Services menu is highlighted, press OK to enter the Services menu.	
3	Press  to select the Date-Time setting sub-menu and press OK to enter.	
4	You can now access the date and time settings. You can also press  to return to the Services menu, or press  on the right to return to the main menu.	

Editing Values

Overview

You can use the **▼**, **▲**, and **OK** keys to select and edit settings. There are 2 ways to edit setting values using the LTM CU:

- Select an item in a value list
- Edit a numerical value, one digit at a time

NOTE: Some settings, although expressed as numerical values, are selected in the same way as an item in a value list. For example, a setting with a value that is expressed in units, but can be incremented or decremented only by tens or hundreds of units, is edited by scrolling through a value list.

The LTM CU enables the configuration and modification of 2 types of parameters:

- the main parameters of the LTM R through the configuration mode,
- the other parameters.

Editing any value requires familiarity with the LTM CU menu structure, and general navigation principles.

- For information on menu navigation, see *Navigating the Menu Structure, page 45*.
- For information on the menu structure, see *Main Menu, page 52*.

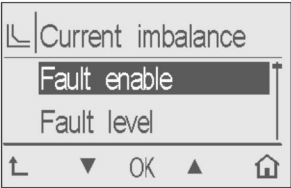
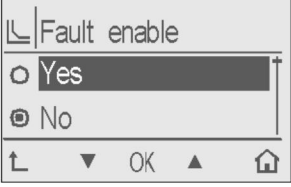
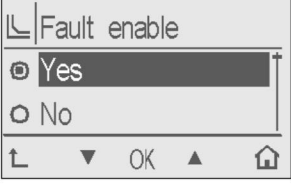
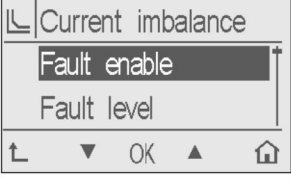

Selecting Values in a List

The following example describes how to set the Current phase imbalance fault enable parameter by selecting the Yes value in a list:

Step	Description	Screen display
1	Select Protection settings - Current - Current imbalance. Use ▼ or ▲ to select Fault enable and press OK .	
2	Select Yes and press OK .	
3	The radio button beside the selection indicates the parameter's saved setting.	
4	After a few seconds, the display automatically returns to the Current imbalance menu. You can then navigate to another parameter to continue configuration or return to the main menu.	

Editing Numerical Values

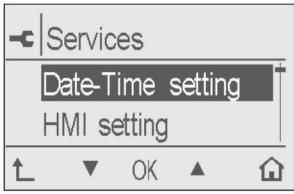
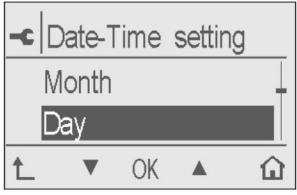
The following example describes setting the date and time parameters by editing numerical values:

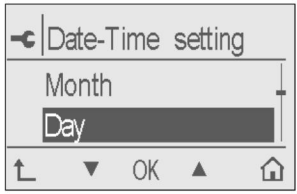
Step	Description	Screen display
1	Select Services - Date-Time setting to navigate to the date and time parameters, then press OK .	 The screenshot shows a menu titled "Services" with a left arrow icon. Two options are listed: "Date-Time setting" and "HMI setting". The "Date-Time setting" option is highlighted with a black bar. At the bottom, there are navigation icons: a left arrow, a downward arrow, "OK", an upward arrow, and a home icon.
2	Use ▼ or ▲ to select Day and press OK .	 The screenshot shows a menu titled "Date-Time setting" with a left arrow icon. Two options are listed: "Month" and "Day". The "Day" option is highlighted with a black bar. At the bottom, there are navigation icons: a left arrow, a downward arrow, "OK", an upward arrow, and a home icon.
3	Use + or - to increase or decrease the selected value.	 The screenshot shows a screen titled "Day" with a left arrow icon. The value "09" is displayed in the center. At the bottom, there are navigation icons: a left arrow, a plus sign, "OK", a minus sign, and a right arrow.
4	Press ► to select the second digit for editing, use + or - to increase or decrease the selected value, then press OK to save the setting.	 The screenshot shows a screen titled "Day" with a left arrow icon. The value "19" is displayed in the center. At the bottom, there are navigation icons: a left arrow, a plus sign, "OK", a minus sign, and a right arrow.
5	The display then automatically returns to the Date and Time menu.	 The screenshot shows a menu titled "Date-Time setting" with a left arrow icon. Two options are listed: "Month" and "Day". The "Day" option is highlighted with a black bar. At the bottom, there are navigation icons: a left arrow, a downward arrow, "OK", an upward arrow, and a home icon.

Configuration Mode

The LTM CU is in configuration mode:

- by default in the First setup menu, see *First Setup Menu, page 51*, or
- from the main menu, select Services menu then Config, Enter config.

When the LTM R is in configuration mode, the  icon is displayed in the right top corner of the information area:

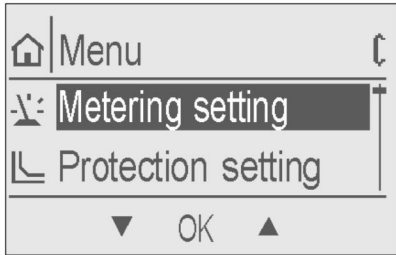

The procedure below describes how to edit parameters in configuration mode:

Step	Action
1	In configuration mode, edit parameters.
2	When all parameters are set, the last menu item to appear is End config: press OK to validate.
3	Select Yes to save the configuration or No to cancel changes.

NOTE: In configuration mode, access to the Quick View display is not proposed.

For more information on the configurable parameters in configuration mode only, see the TeSys® T LTM R Motor Management Controller User's Manuals.

Password Access

Overview

You can set a password for the LTM CU to limit access to configuration of LTM R controller parameters to authorized personnel. When a password has been set, other users can view the information displayed by the LTM CU, but cannot edit parameter values.

Entering a Password

The LTM CU password must be an integer from 0000 to 9999.

The process of entering a password is similar to editing a numerical setting.

Step	Description
1	Select Services - HMI setting - Password - Change passwd to navigate to the HMI Keypad Password parameter.
2	Press OK to step into the Password setting. The value 0000 appears by default, and is not necessarily the active password.
3	Press OK again to select the first (left-most) digit for editing.
4	Use + or - to increase or decrease the first digit value.
5	Press ▶ to move to the second digit for editing. Use + or - to increase or decrease the second digit value. Note: Other digits remain hidden and are displayed as an asterisk.
6	Press ▶ to move to the third digit for editing. Use + or - to increase or decrease the third digit value.
7	Press ▶ to move to the fourth digit for editing. Use + or - to increase or decrease the fourth digit value.
8	Press OK to complete the entry of the new password. The LCD displays the screen for confirming the new password.
9	Repeat steps 3 through 8. When the new password is confirmed, the LCD returns to the previous (higher) level screen.

Authorizing Parameters Editing

When password protection is enabled, editing a parameter setting requires entering the password.

The process of entering a password is similar to editing a numerical setting.

Step	Description
1	Press contextual menu navigation keys to navigate to the parameter to edit.
2	Press  . The screen to enter the password is displayed.
3	Press OK to select the first (left-most) digit for editing.
4	Use + or - to increase or decrease the first digit value.
5	Press ▶ to move to the second digit for editing. Use + or - to increase or decrease the second digit value. Note: Other digits remain hidden and displayed as an asterisk.
6	Press ▶ to move to the third digit for editing. Use + or - to increase or decrease the third digit value.
7	Press ▶ to move to the fourth digit for editing. Use + or - to increase or decrease the fourth digit value.
8	Press OK to complete the entry of the password. When the password is confirmed, you can edit the parameter value.

Password Activation/Deactivation

Enter a password value from 0001 to 9999 to enable password protection.



Enter a password value of 0000 to disable password protection.

Password protection is disabled by default.

Selecting the Language Displayed by the LTM CU

Procedure

The procedure below enables you to select one language stored in the LTM CU memory:

Step	Action
1	Press  to return to the LTM CU main menu.
2	Display the Language sub-menu by: <ul style="list-style-type: none"> • either navigating the menu structure: Menu/Services/HMI setting/Language, • or select the  Language sub-menu from the main menu.
3	Select a language among the list of stored languages. Up to 3 stored languages are available.
4	Use the ▼ and ▲ keys to select a language among the list of stored languages. Press OK .

The LTM CU will now display the language you have selected.

NOTE: If you want to display another language, you can download other languages by using a PC running the LTMCU Langtool language management software: see *Language Management*, page 25.

First Setup Menu

Definition

The First setup menu displays as follows:

- On power-up, if the connected LTM R is not configured (first power-up or after executing a Clear all command in the Services menu), the parameters must be configured according to the connected LTM R and the Controller system config required to get the LTM CU operational.
- On subsequent power-ups after selecting Config in the Services menu, see *Menu - Services, page 60*.

The LTM CU is in configuration mode in the First setup menu, see *Sub-Menu Display, page 38*.

First Setup Parameters

The following editable parameters need to be configured before the LTM R can be used. Note that some parameters in the following list may not be available depending on the configuration selections you make:

Level 1	Level 2	Level 3	Parameter name	
First setup	Phases		Motor phases	
	Nominal voltage		Motor nominal voltage	
	Nominal power		Motor nominal power	
	Load CT ratio			Load CT ratio
			Primary	Load CT primary
			Secondary	Load CT secondary
	CT multi passes		Load CT multiple passes	
	Operating mode		Motor operating mode	
	Two-step level ⁽¹⁾		Motor step 1 to 2 threshold	
	Two-step time		Motor step 1 to 2 timeout	
	Star-delta		Motor star-delta	
	Trip type		Thermal overload mode	
	Trip class		Motor trip class	
	FLC1 or OC1 ⁽²⁾		Motor full load current ratio	
	FLC2 or OC2 ⁽³⁾		Motor high speed full load current ratio	
	Definite O-Time		Thermal overload fault definite timeout	
	Local channel		Control local channel setting	
	Network protocol ⁽⁴⁾		Communication protocol	
Language		HMI language setting		
End config		Controller system config required		

(1) Depending on motor operating mode
(2) Depending on trip type
(3) Depending on trip type and motor operating mode
(4) For LTM R Ethernet TCP/IP only

Main Menu

Overview

The LTM CU's main menu gives access to sub-menus which enable access to the parameters required to configure the LTM R. The settings sub-menus are described below:

Sub-menu	Contains	See...
Metering setting	Configurable settings for Motor, Load CT, and Ground CT parameters.	<i>Menu - Metering Setting, page 53</i>
Protection setting	Configurable settings for Thermal, Voltage, Current, Power and Voltage Dip Management parameters.	<i>Menu - Protection Setting, page 54</i>
Control setting	Configurable settings for fallback, remote/local mode, transfer mode, detected fault reset, diagnostics, motor and contactor parameters.	<i>Menu - Control Setting, page 58</i>
Services	Configurable settings for HMI, network, maintenance and detected fault history as well as read-only parameters for product ID. This menu also enables you to set parameters for Quick View.	<i>Menu - Services, page 60</i>
Language	Available languages for the LTM CU display. The default language is English.	<i>Language Management, page 25</i>

NOTE: Not all the parameters listed in the following pages will appear in the LTM CU sub-menus. The parameters available depend on the type and configuration of the system.

Menu - Metering Setting

Metering Setting Menu

The Metering setting menu contains the following sub-menus:

Level 1	Level 2	Level 3
Menu	Metering setting	Motor
		Load CT
		Ground CT
		AC inputs

Motor

The Motor sub-menu contains the following editable parameters:

Level 3	Level 4	Parameter Name
Motor	Phases	Motor phases
	Nominal voltage	Motor nominal voltage
	Nominal power	Motor nominal power
	Temp sensor	Motor temperature sensor type

Load CT

The Load CT sub-menu contains the following editable parameters:

Level 3	Level 4	Level 5	Parameter Name
Load CT	Load CT ratio		Load CT ratio
		Primary	Load CT primary (external CT and specific ratio)
		Secondary	Load CT secondary (external CT and specific ratio)
	CT multi passes		Load CT multiple passes

Ground CT

The Ground CT sub-menu contains the following editable parameters:

Level 3	Level 4	Level 5	Parameter Name
Ground CT	Ground CT ratio		Ground current fault configuration
		Primary	Ground CT primary
		Secondary	Ground CT secondary

AC inputs

The AC inputs sub-menu contains the following editable parameters:

Level 3	Parameter Name
AC inputs	Controller AC logic inputs configuration

Menu - Protection Setting

Protection Settings

The Protection setting menu contains the following sub-menus:

Level 1	Level 2	Level 3
Menu	Protection setting	Thermal
		Current
		Voltage
		Power
		Voltage dip mngt

Thermal

The Thermal sub-menu contains the following editable parameters:

Level 3	Level 4	Level 5	Parameter Name
Thermal	Thermal overload	Trip type	Thermal overload mode
		Trip class	Motor trip class
		Auxiliary fan	Motor auxiliary fan cooled
		Fault enable	Thermal overload fault enable
		FLC1 or OC1	Motor full load current ratio, FLC1
		FLC2 or OC2	Motor high speed full load current ratio, FLC2
		Reset level	Thermal overload fault reset threshold
		Definite O-Time	Thermal overload fault definite timeout
		Warning enable	Thermal overload warning enable
		Warning level	Thermal overload warning threshold
		Temp sensor	Fault enable
	Fault level		Motor temperature sensor fault threshold
	Fault level		Motor temperature sensor fault threshold degree
	Warning enable		Motor temperature sensor warning enable
	Warning level		Motor temperature sensor warning threshold
	Warning level		Motor temperature sensor warning threshold degree

Current

The Current sub-menu contains the following editable parameters:

Level 3	Level 4	Level 5	Parameter Name
Current	Current imbalance	Fault enable	Current phase imbalance fault enable
		Fault level	Current phase imbalance fault threshold
		Fault time starting	Current phase imbalance fault timeout starting
		Fault time running	Current phase imbalance fault timeout running
		Warning enable	Current phase imbalance warning enable
		Warning level	Current phase imbalance warning threshold
	Current ph loss	Fault enable	Current phase loss fault enable
		Fault time	Current phase loss timeout
		Warning enable	Current phase loss warning enable
	Current ph rev	Phase sequence	Motor phases sequence
		Fault enable	Current phase reversal fault enable
	Long start	Fault enable	Long start fault enable
		Fault level	Long start fault threshold
		Fault time	Long start fault timeout
	Jam	Fault enable	Jam fault enable
		Fault level	Jam fault threshold
		Fault time	Jam fault timeout
		Warning enable	Jam warning enable
		Warning level	Jam warning threshold
	Undercurrent	Fault enable	Undercurrent fault enable
		Fault level	Undercurrent fault threshold
		Fault time	Undercurrent fault timeout
		Warning enable	Undercurrent warning enable
		Warning level	Undercurrent warning threshold
	Overcurrent	Fault enable	Overcurrent fault enable
		Fault level	Overcurrent fault threshold
		Fault time	Overcurrent fault timeout
Warning enable		Overcurrent warning enable	
Warning level		Overcurrent warning threshold	
Current (continued)	Ground current	Start disable	Ground current fault disabled in start
		Fault enable	Ground current fault enable
		Fault level	Internal ground current fault threshold
		Fault level	External ground current fault threshold
		Fault time	Internal ground current fault timeout
		Fault time	External ground current fault timeout
		Warning enable	Ground current warning enable
		Warning level	Internal ground current warning threshold
		Warning level	External ground current warning threshold

Voltage

The Voltage sub-menu contains the following editable parameters:

Level 3	Level 4	Level 5	Parameter Name
Voltage	Voltage imbalance	Fault enable	Voltage phase imbalance fault enable
		Fault level	Voltage phase imbalance fault threshold
		Fault time starting	Voltage phase imbalance fault timeout starting
		Fault time running	Voltage phase imbalance fault timeout running
		Warning enable	Voltage phase imbalance warning enable
		Warning level	Voltage phase imbalance warning threshold
	Voltage ph loss	Fault enable	Voltage phase loss fault enable
		Fault time	Voltage phase loss fault timeout
		Warning enable	Voltage phase loss warning enable
	Voltage ph rev	Fault enable	Voltage phase reversal fault enable
	Undervoltage	Fault enable	Undervoltage fault enable
		Fault level	Undervoltage fault threshold
		Fault time	Undervoltage fault timeout
		Warning enable	Undervoltage warning enable
	Overvoltage	Warning level	Undervoltage warning threshold
		Fault enable	Overvoltage fault enable
		Fault level	Overvoltage fault threshold
		Fault time	Overvoltage fault timeout
		Warning enable	Overvoltage warning enable
	Warning level	Overvoltage warning threshold	

Power

The Power sub-menu contains the following editable parameters:

Level 3	Level 4	Level 5	Parameter Name
Power	Underpower	Fault enable	Underpower fault enable
		Fault level	Underpower fault threshold
		Fault time	Underpower fault timeout
		Warning enable	Underpower warning enable
		Warning level	Underpower warning threshold
	Overpower	Fault enable	Overpower fault enable
		Fault level	Overpower fault threshold
		Fault time	Overpower fault timeout
		Warning enable	Overpower warning enable
		Warning level	Overpower warning threshold
	Under power fact	Fault enable	Under power factor fault enable
		Fault level	Under power factor fault threshold
		Fault time	Under power factor fault timeout
		Warning enable	Under power factor warning enable
		Warning level	Under power factor warning threshold
	Over power fact	Fault enable	Over power factor fault enable
		Fault level	Over power factor fault threshold
		Fault time	Over power factor fault timeout
		Warning enable	Over power factor warning enable
		Warning level	Over power factor warning threshold

Voltage Dip Management

The Voltage dip mngt sub-menu contains the following editable parameters:

Level 3	Level 4	Parameter Name
Voltage dip mngt	Function	Voltage dip mode
	Loss level	Voltage dip threshold
	Loss time	Load shedding timeout
	Immediate time	Auto restart immediate timeout
	Delayed time	Auto restart delayed timeout
	Restart level	Voltage dip restart threshold
	Restart time	Voltage dip restart timeout

Menu - Control Setting

Control Setting Menu

The Control setting menu contains the following sub-menus:

Level 1	Level 2	Level 3
Menu	Control setting	Fallback
		Remote / Local
		Stop enable
		LI3 assignment
		Diagnostics
		Fault reset
		Motor
		Contactora

Fallback

The Fallback sub-menu contains the following editable parameters:

Level 3	Level 4	Parameter Name
Fallback	HMI fallback	HMI port fallback setting
	Network fallback	Network port fallback setting

Remote/Local

The Remote / Local sub-menu contains the following editable parameters:

Level 3	Level 4	Parameter Name
Remote/Local	Remote channel	Control remote channel setting
	Local channel	Control local channel setting
	HMI R/L enable	HMI remote local buttons enable
	Power-up mode	HMI remote local default mode
	Transfer mode	Control transfer mode

Stop enable

The Stop enable sub-menu contains the following editable parameters:

Level 3	Level 4	Parameter Name
Stop enable	Terminals	Stop terminal strip disable
	HMI	Stop HMI disable

LI3 assignment

The LI3 assignment sub-menu contains the following editable parameter:

Level 3	Parameter Name
LI3 assignment	Logic input 3 external ready enable

Diagnostics

The Diagnostics sub-menu contains the following editable parameters:

Level 3	Level 4	Level 5	Parameter Name
Diagnostics	Wiring error	Fault enable	Wiring fault enable
	On-Off diagnostic	Fault enable	Diagnostic fault enable
		Warning enable	Diagnostic warning enable

Fault Reset

The Fault reset sub-menu contains the following editable parameters:

Level 3	Level 4	Level 5	Parameter Name
Fault reset	Reset mode	-	Fault reset mode
	Autoreset group 1	Reset number	Auto-reset attempts group 1 setting
		Reset time	Auto-reset group 1 timeout
	Autoreset group 2	Reset number	Auto-reset attempts group 2 setting
		Reset time	Auto-reset group 2 timeout
	Autoreset group 3	Reset number	Auto-reset attempts group 3 setting
		Reset time	Auto reset group 3 timeout

Motor

The Motor sub-menu contains the following editable parameters:

Level 3	Level 4	Parameter Name
Motor	Operating Mode	Motor operating mode
	Rapid cycle time	Rapid cycle lockout timeout
	Direct transition	Control direct transition
	Transition time	Motor transition timeout
	Two-step level	Motor step 1 to 2 threshold
	Two-step time	Motor step 1 to 2 timeout
	Star-delta	Motor star-delta

Contactors

The Contactors sub-menu contains the following editable parameters:

Level 3	Level 4	Parameter Name
Contactors	Contactors rating	Contactors rating

Menu - Services

Services Menu

The Services menu contains the following sub-menus:

Level 1	Level 2	Level 3
Menu	Services	Date-Time setting
		HMI setting
		Network
		History
		Config
		Settings
		Product ID
		Self test
		Clear

The Services sub-menus are described below.

Date-Time Setting

The Date-Time setting sub-menu contains the following editable parameters:

Level 3	Level 4	Parameter Name
Date-Time setting	Year	Date and time setting
	Month	
	Day	
	Hour	
	Minutes	
	Seconds	

HMI Setting

The HMI Setting sub-menu contains the following editable parameters:

Level 3	Level 4	Parameter Name
HMI setting	Language	HMI language setting
	Contrast	HMI display contrast setting
	Brightness	HMI display brightness setting
	Run LED color	HMI motor status LED color
	Degree unit	Motor temperature sensor display degree CF

Level 3	Level 4	Level 5	Parameter Name
HMI setting (continued)	Quick View	Motor status	HMI display motor status enable
		Date	HMI display date enable
		Time	HMI display time enable
		Last start	HMI display start statistics enable
		Thermal capacity	HMI display thermal capacity level enable
		Remain th cap	HMI display thermal capacity remaining enable
		Time to trip	HMI display time to trip enable
		Average voltage	HMI display average voltage enable
		L1-L2 voltage	HMI display L1-L2 voltage enable
		L2-L3 voltage	HMI display L2-L3 voltage enable
		L3-L1 voltage	HMI display L3-L1 voltage enable
		Voltage imbalance	HMI display voltage phase imbalance enable
		Average current	HMI display average current enable
		L1 current	HMI display L1 current enable
		L2 current	HMI display L2 current enable
		L3 current	HMI display L3 current enable
		Avg current in%	HMI display average current ratio enable
		L1 current in%	HMI display L1 current ratio enable
		L2 current in%	HMI display L2 current ratio enable
		L3 current in%	HMI display L3 current ratio enable
		Current imbalance	HMI display current phase imbalance enable
		Ground current	HMI display ground current enable
		Active power	HMI Display active power enable
		Reactive power	HMI display reactive power enable
		Power Wh	HMI Display power consumption enable
		Power factor	HMI display power factor enable
		Frequency	HMI display frequency enable
		Temp sensor	HMI motor temperature sensor enable
		Operating time	HMI display operating time enable
		Starts per hour	HMI display starts per hour enable
I/O status	HMI display I/O status enable		
Control mode	HMI display control mode enable		

Level 3	Level 4	Level 5	Level 6	Parameter Name
HMI Setting (continued)	Password	Change passwd		HMI keypad password
		HMI comm	Baud rate	
	Parity		HMI port parity setting	
	Comm Loss		Fault enable	HMI port fault enable
		Warning enable	HMI port warning enable	

Network (Modbus, Profibus, CANopen, DeviceNet)

The Network sub-menu contains the following parameters:

Level 3	Level 4	Level 5	Level 6	Parameter Name	
Network	Network settings	Address		Network port address setting	
		Baud rate ⁽¹⁾		Network port baud rate setting	
		Parity ⁽²⁾		Network port parity setting	
		Endian		Network port endian setting	
		Comm loss	Fault enable		Network port fault enable
			Warning enable		Network port warning enable
			Network timeout ⁽¹⁾		Network port comm loss timeout
	Device Status	Baud rate ⁽¹⁾		Network port baud rate	
		Parity ⁽²⁾		Network port parity	
		Address		Network port address setting	
(1) Except for LTM R Profibus					
(2) LTM R Modbus only					

Network (Ethernet TCP/IP)

The Network sub-menu contains the following parameters:

Level 3	Level 4	Level 5	Level 6	Parameter Name	
Network	Network settings	IP address		Ethernet IP address setting	
		Subnet mask		Ethernet subnet mask setting	
		Gateway		Ethernet gateway address setting	
		Endian		Network port endian setting	
		Frame type		Network port frame type setting	
		Network protocol		Communication protocol status	
		FDR	FDR disable		Network port FDR disable
			Auto backup		Network port FDR auto backup enable
			Backup period		Network port FDR auto backup period setting
		Comm loss	Master IP address		Ethernet master IP address setting
			Fault enable		Network port fault enable
			Warning enable		Network port warning enable
			Network timeout		Network port comm loss timeout
	Device Status	Address	Device name		Ethernet device name
			MAC address		Ethernet MAC address
			IP address		Ethernet IP address
			Subnet mask		Ethernet subnet mask
			Gateway		Ethernet gateway address
		FDR status		Network port FDR status	

History

The History sub-menu contains the following sub-menus:

Level 1	Level 2	Level 3	Level 4
Menu	Services	History	5 faults history
			Counters
			Motor history
			LTMR History

The 5 faults history sub-menu contains the following sub-menus:

Level 4	Level 5
5 faults history	Fault n-0
	Fault n-1
	Fault n-2
	Fault n-3
	Fault n-4

The **Fault n-0** sub-menu contains the following read only parameters:

Level 3	Level 4	Level 5	Level 6	Parameter Name
History	5 faults history	Fault n-0	Fault name	Fault code n-0
			Date	Date and time n-0
			Time	
			FLC setting in %	Motor full load current ratio n-0
			FLCmax	Full load current max n-0
			Thermal capacity	Thermal capacity level n-0
			Temp sensor	Motor temperature sensor n-0
			Frequency	Frequency n-0
			Average current	Average current n-0
			L1 current	L1 current n-0
			L2 current	L2 current n-0
			L3 current	L3 current n-0
			Ground current	Ground current n-0
			Avg current in %	Average current ratio n-0
			L1 current in %	L1 current ratio n-0
			L2 current in %	L2 current ratio n-0
			L3 current in %	L3 current ratio n-0
			Gnd current in %	Ground current ratio n-0
			Current imbalance	Current phase imbalance n-0
			Average voltage	Average voltage n-0
			L1-L2 voltage	L1-L2 voltage n-0
			L2-L3 voltage	L2-L3 voltage n-0
			L3-L1 voltage	L3-L1 voltage n-0
Voltage imbalance	Voltage phase imbalance n-0			
Active power	Active power n-0			
Power factor	Power factor n-0			

The **Fault n-1** to **Fault n-4** sub-menus contain identical n-1 to n-4 read only parameters.

The **Counters**, **Motor history** and **LTM R history** sub-menus contain the following parameters:

Level 3	Level 4	Level 5	Parameter Name
History	Counters	All faults	Faults count
		All warnings	Warnings count
		Auto reset	Auto-resets count
		Th overld F	Thermal overload faults count
		Th overld W	Thermal overload warnings count
		Temp sens F	Motor temperature sensor faults count
		Cur imbal F	Current phase imbalance faults count
		Cur ph loss F	Current phase loss faults count
		Long start F	Long start faults count
		Jam F	Jam faults count
		Undercur F	Undercurrent faults count
		Overcur F	Overcurrent faults count
		Gnd cur F	Ground current faults count
		Volt imbal F	Voltage phase imbalance faults count
		V ph loss F	Voltage phase loss faults count
		Undervolt F	Undervoltage faults count
		Overvolt F	Overvoltage faults count
		Load shedd	Load sheddings count
		Rstart imm	Auto restart immediate count
		Rstart delay	Auto restart delayed count
		Rstart manu	Auto restart manual count
		UnderPw F	Underpower faults count
		OverPw F	Overpower faults count
Under Pfact F	Under power factor faults count		
Over Pfact F	Over power factor faults count		
HMI loss F	HMI port faults count		
History (continued)	Counters	Net cfg F	Network port config faults count
		Network F	Network port faults count
		Diagnostic F	Diagnostic faults count
		Wiring error	Wiring faults count
		Internal F	Controller internal faults count
		Int link F	Internal port faults count
	Motor history	Operating time	Operating time
		Motor Starts	Motor starts count
		Last start dur	Motor last start duration
		Last start current	Motor last start current ratio
		Power Wh	Active power consumption
		Power VARh	Reactive power consumption
	LTMR History	LTMR max temp	Controller internal temperature max
		LO1 closings	Motor LO1 closings count
		LO2 closings	Motor LO2 closings count

Config

The Config sub-menu contains the following parameters:

Level 3	Level 4	Parameter Name
Config	Enter config	Controller system config required
	End config	

Settings

The Settings sub-menu contains the following parameters:

Level 3	Level 4	Parameter Name	
Settings	FDR backup now	FDR data backup command	
	FDR restore now	FDR data restore command	
	Channels		Config via HMI keypad enable
			Config via HMI engineering tool enable
			Config via network port enable

Product ID

The Product ID sub-menu contains the following read-only parameters:

Level 3	Level 4	Parameter Name
Product ID	LTMR	Controller commercial reference
	LTME	Expansion commercial reference

Self Test

The Self test sub-menu contains the following read-only parameters:

Level 3	Level 4	Parameter Name
Self test	Fault enable	Test fault enable
	Self test now	Self test command

Clear

The Clear sub-menu contains the following editable parameters:

Level 3	Level 4	Parameter Name
Clear	Clear all	Clear all command
	Controller setting	Clear controller settings command
	Network setting	Clear network port settings command
	Statistics	Clear statistics command
	Thermal capacity	Clear thermal capacity level command



A

- AC inputs, 53
- active power
 - consumption, 64
 - n-0, 63
- auto resets
 - count, 64
- auto restart
 - delayed count, 64
 - delayed timeout, 57
 - immediate count, 64
 - immediate timeout, 57
 - manual count, 64
- auto-reset
 - attempts group 1 setting, 59
 - attempts group 2 setting, 59
 - attempts group 3 setting, 59
 - group 1 timeout, 59
 - group 2 timeout, 59
 - group 3 timeout, 59
- average current
 - n-0, 63
- average current ratio
 - n-0, 63
- average voltage
 - n-0, 63

C

- command
 - clear all, 65
 - clear controller settings, 65
 - clear network port settings, 65
 - clear statistics, 65
 - clear thermal capacity level, 65
 - FDR data backup, 65
 - FDR data restore, 65
 - self test, 65
- Communication
 - protocol, 51
 - protocol status, 62
- config via
 - HMI engineering tool enable, 65
 - HMI keypad enable, 65
 - network port enable, 65
- connecting, 23
 - cables, 23
 - RJ45, 23
 - to a PC, 24
 - to LTM R controller, 24
- contactor rating, 59
- control
 - local channel setting, 51, 58
 - remote channel setting, 58
- control direct transition, 59
- Control setting
 - parameters, 58
- control transfer mode, 58

- controller
 - commercial reference, 65
 - internal faults count, 64
 - internal temperature max, 64
 - system config required, 51, 65
- Ground fault
 - disabled in start, 55
- current phase imbalance
 - fault enable, 55
 - fault threshold, 55
 - fault timeout running, 55
 - fault timeout starting, 55
 - faults count, 64
 - n-0, 63
 - warning enable, 55
 - warning threshold, 55
- current phase loss
 - fault enable, 55
 - faults count, 64
 - timeout, 55
 - warning enable, 55
- current phase reversal
 - fault enable, 55

D

- date and time
 - n-0, 63
 - setting, 60
- detected faults and warnings display, 41
- diagnostic
 - fault enable, 58
 - faults count, 64
 - warning enable, 58
- dimensions, 16

E

- Ethernet
 - device name, 62
 - gateway address, 62
 - gateway address setting, 62
 - IP address, 62
 - IP address setting, 62
 - MAC address, 62
 - master IP address setting, 62
 - subnet mask, 62
 - subnet mask setting, 62
- expansion
 - FDR data, 65
- external ground current
 - fault threshold, 55
 - fault timeout, 55
 - warning threshold, 55

F

- fault code
 - n-0, 63

- fault enable
 - motor temperature sensor, 54
- fault reset mode, 59
- faults count, 64
- first setup
 - HMI language, 51
 - parameters, 51
- frequency
 - n-0, 63

G

- ground CT
 - primary, 53
 - ratio, 53
 - secondary, 53
- ground current
 - fault enable, 55
 - faults count, 64
 - n-0, 63
 - warning enable, 55
- ground current ratio
 - n-0, 63

H

- HMI
 - keypad password, 61
 - language setting, 60

- HMI display
 - 31-L1 voltage enable, 61
 - active power enable, 61
 - average current enable, 61
 - average current ratio enable, 61
 - average voltage enable, 61
 - brightness setting, 60
 - contrast setting, 60
 - control mode enable, 61
 - current phase imbalance enable, 61
 - date setting, 61
 - frequency enable, 61
 - ground current enable, 61
 - I/O status enable, 61
 - L1 current enable, 61
 - L1 current ratio enable, 61
 - L1-L2 voltage enable, 61
 - L2 current enable, 61
 - L2 current ratio enable, 61
 - L2-L3 voltage enable, 61
 - L3 current enable, 61
 - L3 current ratio enable, 61
 - last fault enable, 61
 - last warning enable, 61
 - motor status enable, 61
 - motor status LED color, 60
 - motor temperature sensor enable, 61
 - operating time enable, 61
 - power consumption enable, 61
 - power factor enable, 61
 - reactive power enable, 61
 - start statistics enable, 61
 - starts per hour enable, 61
 - thermal capacity level enable, 61
 - thermal capacity remaining enable, 61
 - time setting, 61
 - time to trip enable, 61
 - voltage phase imbalance enable, 61
- HMI port
 - baud rate setting, 61
 - fallback setting, 58
 - faults count, 64
 - parity setting, 61
- HMI remote local key default, 58
- HMI remote local key enable, 58

I

- interface
 - physical description, 34
- internal ground current
 - fault threshold, 55
 - fault timeout, 55
 - warning threshold, 55
- internal port
 - faults count, 64

J

jam

- fault enable, 55
- fault threshold, 55
- fault timeout, 55
- faults count, 64
- warning enable, 55
- warning threshold, 55

L

L1 current

- n-0, 63

L1 current ratio

- n-0, 63

L1-L2 voltage

- n-0, 63

L2 current

- n-0, 63

L2 current ratio

- n-0, 63

L2-L3 voltage

- n-0, 63

L3 current

- n-0, 63

L3 current ratio

- n-0, 63

L3-L1 voltage

- n-0, 63

label, 17

- inserting, 17

langtool

- files, 27
- local folder, 27
- patch, 27

language

- LTM CU display, 10
- LTMCU Langtool, 25, 26
- management, 25
- tool, 25

load CT

- multiple passes, 51, 53
- primary, 51, 53
- ratio, 53
- secondary, 51, 53

load shedding

- timeout, 57

load sheddings count, 64

local control interface, 42

- control keys, 42
- label, 17
- LEDs, 43

logic input 3 external ready enable, 58

long start

- fault enable, 55
- fault threshold, 55
- fault timeout, 55
- faults count, 64

LTM CU

- contextual navigation keys, 34
- displays, 36
- language, 50

LTM CU display

- icons, 35

LTMCU Langtool, 26, 28

- download, 26
- download area, 29
- Language folder, 28, 29
- language selection, 31
- LTM CU area, 29
- PC area, 29

M

menus

- Control setting, 58
- First setup, 51
- main menu, 52
- Menu, 52
- Metering setting, 53
- navigating, 45
- Protection setting, 54
- Services, 60

Metering setting

- parameters, 53

motor

- auxiliary fan cooled, 54
- full load current ratio, 51
- full load current ratio, FLC1, 54
- high speed full load current ratio, 51
- high speed full load current ratio, FLC2, 54
- nominal power, 51, 53
- nominal voltage, 51, 53
- operating mode, 51, 59
- phases, 51, 53
- phases sequence, 55
- step 1 to 2 threshold, 51, 59
- step 1 to 2 timeout, 51, 59
- temperature sensor fault threshold, 54
- temperature sensor fault threshold degree, 54
- temperature sensor type, 53
- temperature sensor warning threshold, 54
- temperature sensor warning threshold degree, 54
- transition timeout, 59
- trip class, 51, 54

motor full load current max

- n-0, 63

motor full load current ratio

- n-0, 63

motor last start current duration, 64

motor last start duration, 64

motor star delta, 51, 59

motor starts count, 64

motor temperature sensor

- display CF, 60
- faults count, 64
- n-0, 63

mounting, 19

N

- network port
 - address, 62
 - address setting, 62
 - baud rate, 62
 - baud rate setting, 62
 - comm loss timeout, 62, 62
 - config faults count, 64
 - endian setting, 62, 62
 - fallback setting, 58
 - fault enable, 62, 62
 - faults count, 64
 - FDR auto backup enable, 62
 - FDR auto backup period setting, 62
 - FDR disable, 62
 - frame type setting, 62
 - parity, 62
 - parity setting, 62
 - warning enable, 62, 62
- network port
 - FDR status, 62

O

- operating time, 64
- over power factor
 - fault enable, 56
 - fault threshold, 56
 - fault timeout, 56
 - faults count, 64
 - warning enable, 56
 - warning threshold, 56
- overcurrent
 - fault enable, 55
 - fault threshold, 55
 - fault timeout, 55
 - faults count, 64
 - warning enable, 55
 - warning threshold, 55
- overpower
 - fault enable, 56
 - fault threshold, 56
 - fault timeout, 56
 - faults count, 64
 - warning enable, 56
 - warning threshold, 56
- overvoltage
 - fault enable, 56
 - fault threshold, 56
 - fault timeout, 56
 - faults count, 64
 - warning enable, 56
 - warning threshold, 56

P

- password
 - access, 49
- power factor
 - n-0, 63
- protection
 - password, 49
- Protection setting
 - parameters, 54

Q

- Quick View, 34, 35, 36, 39
 - automatic scroll mode, 39
 - manual scroll mode, 40

R

- rapid cycle
 - lockout timeout, 59
- reactive power
 - consumption, 64

S

- Services
 - parameters, 60
- SoMove, 10
- starts count
 - motor LO1, 64
 - motor LO2, 64
- stop HMI disable, 58
- stop terminal strip disable, 58

T

- test fault enable, 65
- thermal capacity level
 - n-0, 63
- thermal overload
 - fault definite timeout, 51, 54
 - fault enable, 54
 - fault reset threshold, 54
 - faults count, 64
 - mode, 51, 54
 - warning enable, 54
 - warning threshold, 54
 - warnings count, 64

U

- under power factor
 - fault enable, 56
 - fault threshold, 56
 - fault timeout, 56
 - faults count, 64
 - warning enable, 56
 - warning threshold, 56
- undercurrent
 - fault enable, 55
 - fault threshold, 55
 - fault timeout, 55
 - faults count, 64
 - warning enable, 55
 - warning threshold, 55
- underpower
 - fault enable, 56
 - fault threshold, 56
 - fault timeout, 56
 - faults count, 64
 - warning enable, 56
 - warning threshold, 56

- undervoltage
 - fault enable, 56
 - fault threshold, 56
 - fault timeout, 56
 - faults count, 64
 - warning enable, 56
 - warning threshold, 56

V

- values
 - editing in a list, 46
 - editing numerical values, 47
- voltage dip
 - mode, 57
 - restart threshold, 57
 - restart timeout, 57
 - threshold, 57
- voltage phase imbalance
 - fault enable, 56
 - fault threshold, 56
 - fault timeout, 56
 - fault timeout running, 56
 - fault timeout starting, 56
 - faults count, 64
 - n-0, 63
 - warning enable, 56
 - warning threshold, 56
- voltage phase loss
 - fault enable, 56
 - faults count, 64
 - warning enable, 56
- voltage phase reversal
 - fault enable, 56

W

- warning enable
 - motor temperature sensor, 54
- warnings count, 64
- wiring
 - fault enable, 58
 - faults count, 64



1639581EN-04

Schneider Electric Industries SAS

35, rue Joseph Monier
CS30323
F - 92506 Rueil Malmaison Cedex

www.schneider-electric.com

As standards, specifications and designs change from time to time, please ask for confirmation of the information given in this publication.

06/2014



RSPSupply - 1-888-532-2706 - <https://www.RSPSupply.com>
See the product details here